MANUAL



MODEL **1211**

MOTOR CONTROLLER

© 2007 CURTIS INSTRUMENTS, INC.

DESIGN OF CURTIS 1200 SERIES
CONTROLLERS PROTECTED BY U.S.
PATENT NO. 4626750.

1211 Manual, p/n 37791
Rev. E: July 2007



CURTIS INSTRUMENTS, INC.

200 Kisco Avenue
Mt. Kisco, New York 10549 USA
Tel. 914.666.2971
Fax 914.666.2188

www.curtisinstruments.com

CONTENTS

1.	OVERVIEW.....	1
2.	INSTALLATION AND WIRING.....	4
	Mounting the Controller.....	4
	Connections: High Current.....	5
	Connections: Low Current.....	5
	Standard Installation, 6-pin models.....	6
	Standard Installation, 9-pin models with speed limit pot at Pin 7 (TÜV compliant).....	7
	Standard Installation, 9-pin models with reverse switch at Pin 7.....	8
	Throttle Wiring.....	9
	Switches and Other Hardware.....	10
3.	INSTALLATION CHECKOUT.....	12
4.	PROGRAMMABLE PARAMETERS.....	13
	<i>Motor Parameters</i>	13
	Main Current Limit.....	14
	Motor Resistance.....	14
	Measure Resistance.....	14
	<i>Acceleration Parameters</i>	14
	Forward Acceleration Rate, Maximum Speed.....	14
	Forward Acceleration Rate, Minimum Speed.....	14
	Reverse Acceleration Rate, Maximum Speed.....	15
	Reverse Acceleration Rate, Minimum Speed.....	15
	<i>Braking Parameters</i>	15
	Forward Deceleration Rate, Maximum Speed.....	15
	Forward Deceleration Rate, Minimum Speed.....	15
	Reverse Deceleration Rate, Maximum Speed.....	16
	Reverse Deceleration Rate, Minimum Speed.....	16
	Soft Stop Speed.....	16
	Key Off Deceleration.....	16
	Brake Delay.....	17
	E-Stop.....	17
	<i>Speed Parameters</i>	17
	Maximum Forward Speed.....	17
	Minimum Forward Speed.....	17

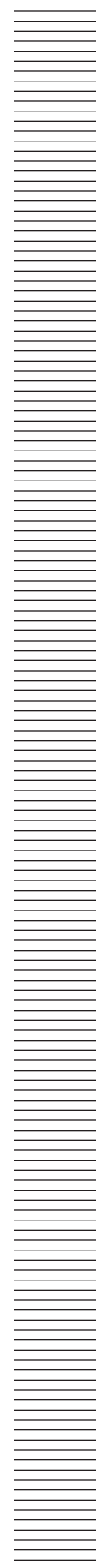

Maximum Reverse Speed	17
Minimum Reverse Speed	18
IR Compensation.....	18
<i>Throttle Parameters</i>	19
Throttle Input Signal Type.....	19
Throttle Autocalibration	19
Throttle Deadband	20
Throttle Gain.....	21
Ramp Shape (Static Throttle Map)	22
<i>Fault Parameters</i>	24
High Pedal Disable (HPD)	24
Brake Faults	24
Fault Beep.....	24
<i>Other Parameters</i>	25
Sleep Delay	25
Tremor Compensation	25
Reverse Beep	25
Beeper Solid	25
5. TUNING YOUR CONTROLLER	26
Beginning the Tuning Procedures	26
Throttle	26
Determining Motor Resistance.....	28
Setting the Maximum Speeds	28
Setting the Acceleration and Deceleration Rates.....	29
Adjusting Load Compensation	31
Adjusting Tremor Compensation.....	32
6. PROGRAMMER MENUS	33
7. DIAGNOSTICS AND TROUBLESHOOTING	35
8. MAINTENANCE.....	38
APPENDIX A Vehicle Design Considerations Regarding Electromagnetic Compatibility (EMC) and Electrostatic Discharge (ESD)	A-1
APPENDIX B Programmer Operation	B-1
APPENDIX C Specifications.....	C-1

FIGURES

FIG. 1:	Curtis 1211 electronic motor controller	1
FIG. 2:	Mounting dimensions, Curtis 1211 controller	4
FIG. 3:	Low-current connections	5
FIG. 4:	High-current connections	5
FIG. 5a:	Standard wiring configuration, 6-pin models	6
FIG. 5b:	Standard wiring configuration, 9-pin TÜV-compliant models (speed limit pot at pin 7)	7
FIG. 5c:	Standard wiring configuration, 9-pin reverse-switch models (reverse switch at pin 7)	8
FIG. 6:	Wiring for 5kΩ, 3-wire potentiometer	9
FIG. 7:	Wiring for 5V throttle	10
FIG. 8:	Wiring to inhibit operation during battery charging	11
FIG. 9:	Effect of adjusting the neutral deadband parameter	12
FIG. 10:	Effect of adjusting the throttle gain parameter	22
FIG. 11:	Ramp shape (throttle map) for controller with maximum speed set at 100%	23
FIG. 12:	Ramp shape (throttle map) for controller with maximum speed set at 60%	23
FIG. B-1:	Curtis 1311 handheld programmer	B-1

TABLES

TABLE 1:	Programmable throttle input signal types	19
TABLE 2:	Status LED fault codes	36
TABLE 3:	Troubleshooting chart	37
TABLE C-1:	Specifications, 1211 controller	C-1

1

OVERVIEW

The Curtis EnAble™ 1211 permanent magnet motor controller is a complete system solution offering unparalleled driving characteristics for mobility aid scooters and other small electric vehicles. It is designed to provide excellent performance, reliability, and ruggedness in a very compact size. The built-in harness reduces OEM manufacturing costs, while eliminating wiring at the base of the scooter. This robust microprocessor-based controller is packaged in a full metal enclosure, is completely sealed to dust and water, and has excellent EMC characteristics.

Standard 1211 controllers are available with either a 6-pin or 9-pin logic connector, and are equipped with a programmer cable to allow programming via the Curtis 1311 and 1314 programmers.

Custom 1211 controllers (6-pin or 9-pin) are delivered factory-programmed to the OEM's specifications. These pre-programmed models are the most cost-effective, and can only be manufactured in quantity. Typically they are specified with no programmer cable.

Fig. 1 *Curtis 1211 electronic motor controller. The wiring harness and connectors are included.*



The Curtis 1211 permanent magnet motor speed controller provides:

Smooth and Secure Control

- ✓ Advanced closed-loop speed regulation maintains precise speed over varied terrain, obstacles, curbs, and ramps
- ✓ Linear undervoltage cutback of current ensures smooth control, even with low batteries or on hot days, with no abrupt loss of power
- ✓ Proprietary algorithms help prevent gearbox wear, while providing smooth starts and reversals

- ✓ The vehicle is brought to a complete stop before the electromagnetic brakes are applied, to prevent harsh jarring
- ✓ Inhibit line prevents driving while battery charging
- ✓ Key-Off Decel function ensures smooth braking to a stop when the key is turned off while driving
- ✓ Anti Rollback/Roll-forward function improves vehicle control on hills and ramps
- ✓ Internal main contactor provides secure power-off and reverse battery polarity protection

Easy Installation and Setup

- ✓ Compact size and built-in flying leads make installation a snap
- ✓ Simplified troubleshooting and diagnostics (*9-pin and/or programmable models*)

Additional Features

- ✓ Push-Too-Fast software restricts vehicle top speed, even with the key off
- ✓ Parameters can be easily adjusted with the 1311 handheld programmer or the 1314 PC programmer (*programmable models only*)

Regulatory Compliance

- ✓ FDA documentation available
- ✓ TÜV-compliant models available; see Appendix C
- ✓ Unique power design produces low RF emissions to meet stringent medical limits
- ✓ High RF immunity prevents speed variation and shutdowns in noisy RF environments
- ✓ Controller's power circuits and microprocessor software are continuously monitored for proper operation
- ✓ System start-up checks will disable drive if a defective throttle, brake, or associated wiring is detected
- ✓ Reverse Beeper function alerts bystanders (*9-pin models only*)

Familiarity with your Curtis controller will help you install and operate it properly. We encourage you to read this manual carefully. If you have questions, please contact the Curtis office nearest you.



Working on electric vehicles is potentially dangerous. You should protect yourself against runaways, high current arcs, and outgassing from lead acid batteries:

RUNAWAYS — Some conditions could cause the vehicle to run out of control. **Disconnect the motor or jack up the vehicle and get the drive wheels off the ground** before attempting any work on the motor control circuitry. Note: If the wrong throttle type is selected with the programmer, the vehicle may suddenly begin to move.

HIGH CURRENT ARCS — Electric vehicle batteries can supply very high power, and arcs can occur if they are short circuited. Always open the battery circuit before working on the motor control circuit. **Wear safety glasses, and use properly insulated tools to prevent shorts.**

LEAD ACID BATTERIES — Charging or discharging generates hydrogen gas, which can build up in and around the batteries. Follow the battery manufacturer's safety recommendations. **Wear safety glasses.**

2

INSTALLATION AND WIRING

MOUNTING THE CONTROLLER

The 1211 controller's rugged sealed metal enclosure allows mounting in any orientation. However, care should be taken to protect the wiring from such elements as road debris, oil, etc.

The outline and mounting hole dimensions are shown in Figure 2. The controller should be mounted by means of the two mounting holes in the heatsink, using M4 (#8) screws.

Fig. 2 *Mounting dimensions, Curtis 1211 controller.*

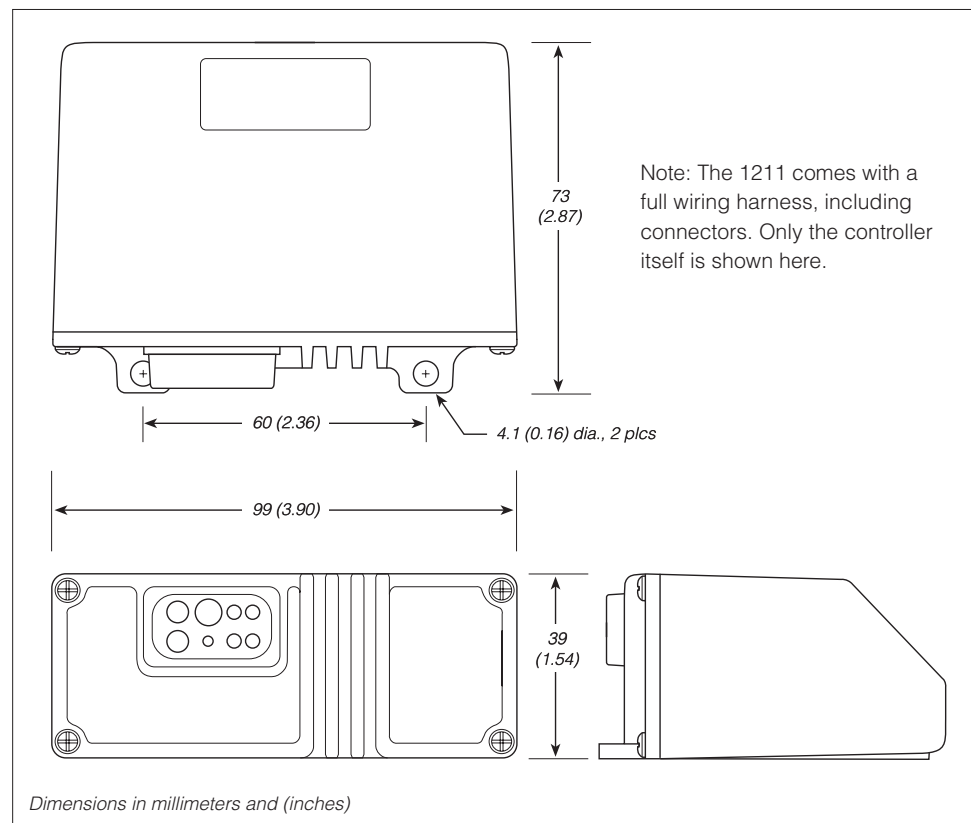

You will need to take steps during the design and development of your end product to ensure that its EMC performance complies with applicable regulations; suggestions are presented in Appendix A.

The 1211 controller contains **ESD-sensitive components**. Use appropriate precautions in connecting, disconnecting, and handling the controller. See installation suggestions in Appendix A for protecting the controller from ESD damage.



CONNECTIONS: High Current

The connections for the motor (M1, M2), the battery (B+, B-), and the battery charger inhibit (INH) extend from the controller as shown in Figure 3. Each cable terminates in a fast-on connector.

Fig. 3 High current connections.

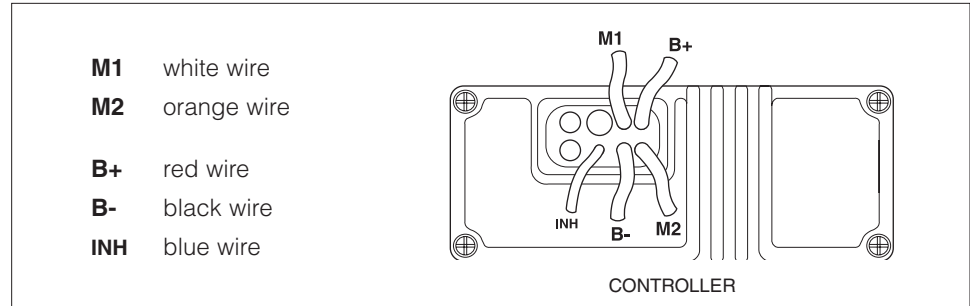

CONNECTIONS: Low Current

The low current wiring extends from the controller as shown below in Figure 4. All standard 1211 controllers have a brake connector (J3), a logic connector (either J2a or J2b), and a connector for the programmer (J1). Pre-programmed custom models are also available, without the programmer connector.

Fig. 4 Low current connections.

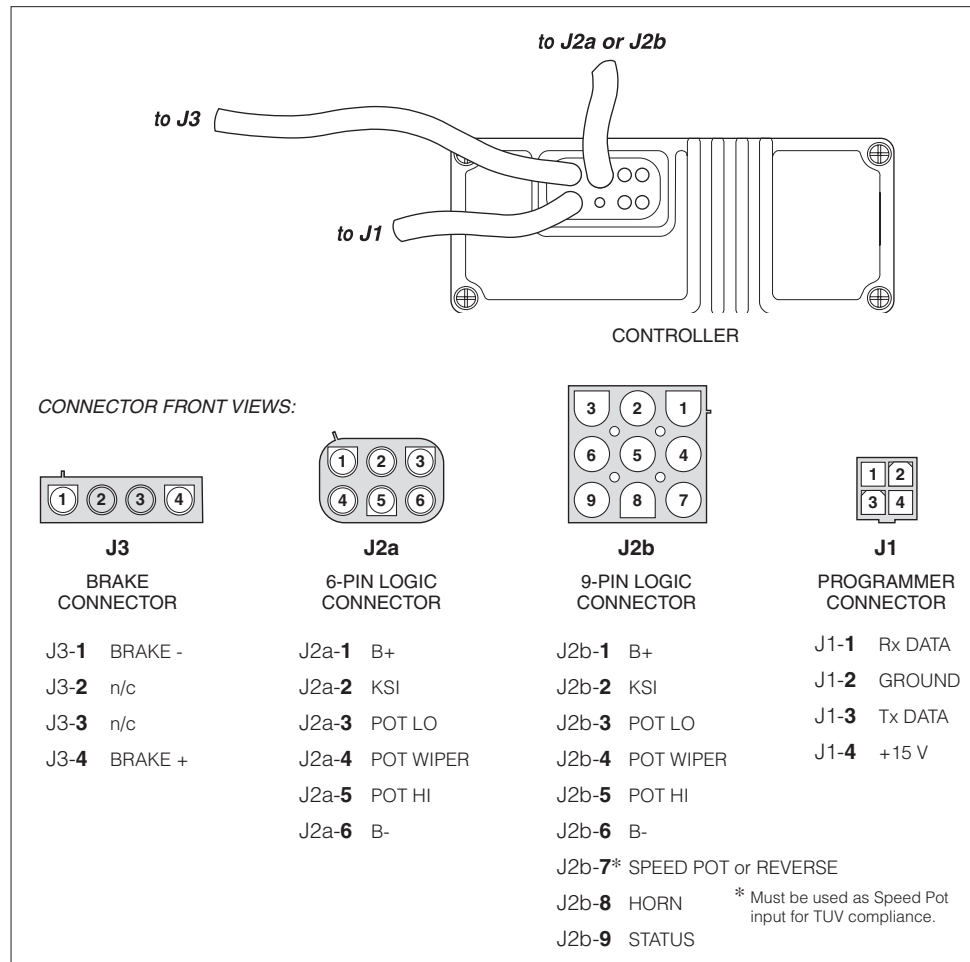

MATING CONNECTORS:

J3	Molex 50-84-2040, with Amp 350690-1 contacts
J2a	Molex 50-84-2062, with Amp 350690-1 contacts
J2b	Amp 1-480706, with Amp 350689-1 contacts
J1	(provided with programmer)

WIRING: STANDARD INSTALLATION, 6-PIN MODELS

The wiring diagram presented in Figure 5a shows a typical installation for controllers with the 6-pin logic connector (J2a). This installation is shown with a 3-wire 5kΩ potentiometer throttle, from which the controller accepts a wigwag throttle input; the circuit does not include a reverse switch. The horn in this installation functions only on demand; it is not part of the logic circuit.

Note: An appropriately sized fuse must be included in the power circuit (as shown) to avoid damage to the controller.

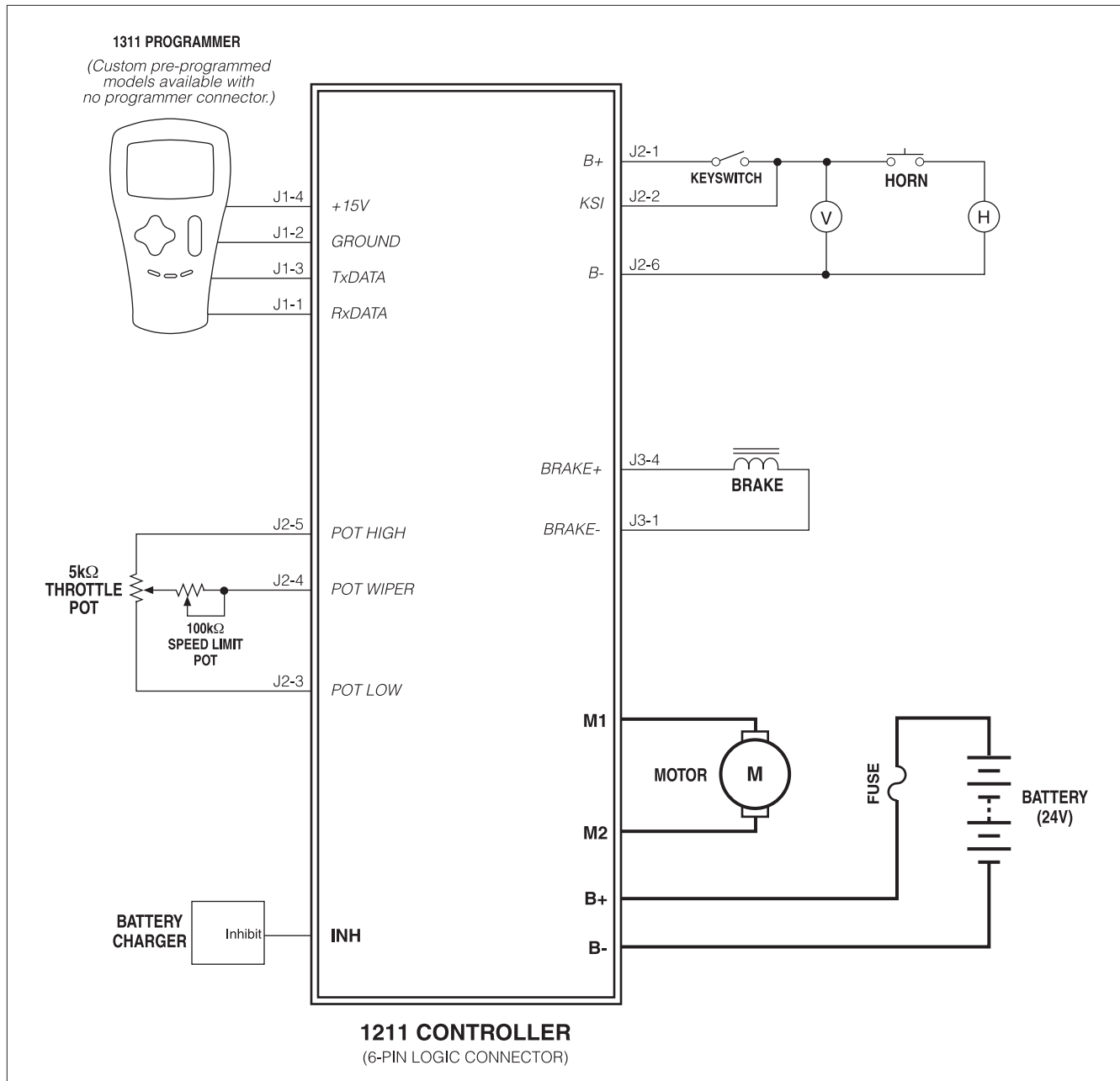

Fig. 5a Standard wiring configuration, Curtis 1211 controller with 6-pin logic connector.

WIRING: STANDARD INSTALLATION, 9-PIN MODELS (TÜV-COMPLIANT OPTION)

The wiring diagram presented in Figure 5b shows a typical installation for controllers with the 9-pin logic connector (**J2b**) in which Pin 7 is a Speed Limit Pot input. This configuration provides accurate pot fault detection as required by TÜV.

The Horn (Pin 8) provides a reverse beep and also sounds the fault codes in the event of a fault. The Status LED (Pin 9) indicates the state of the controller and also enhances its diagnostic capabilities by flashing fault codes.

Note: An appropriately sized fuse must be included in the power circuit (as shown) to avoid damage to the controller.

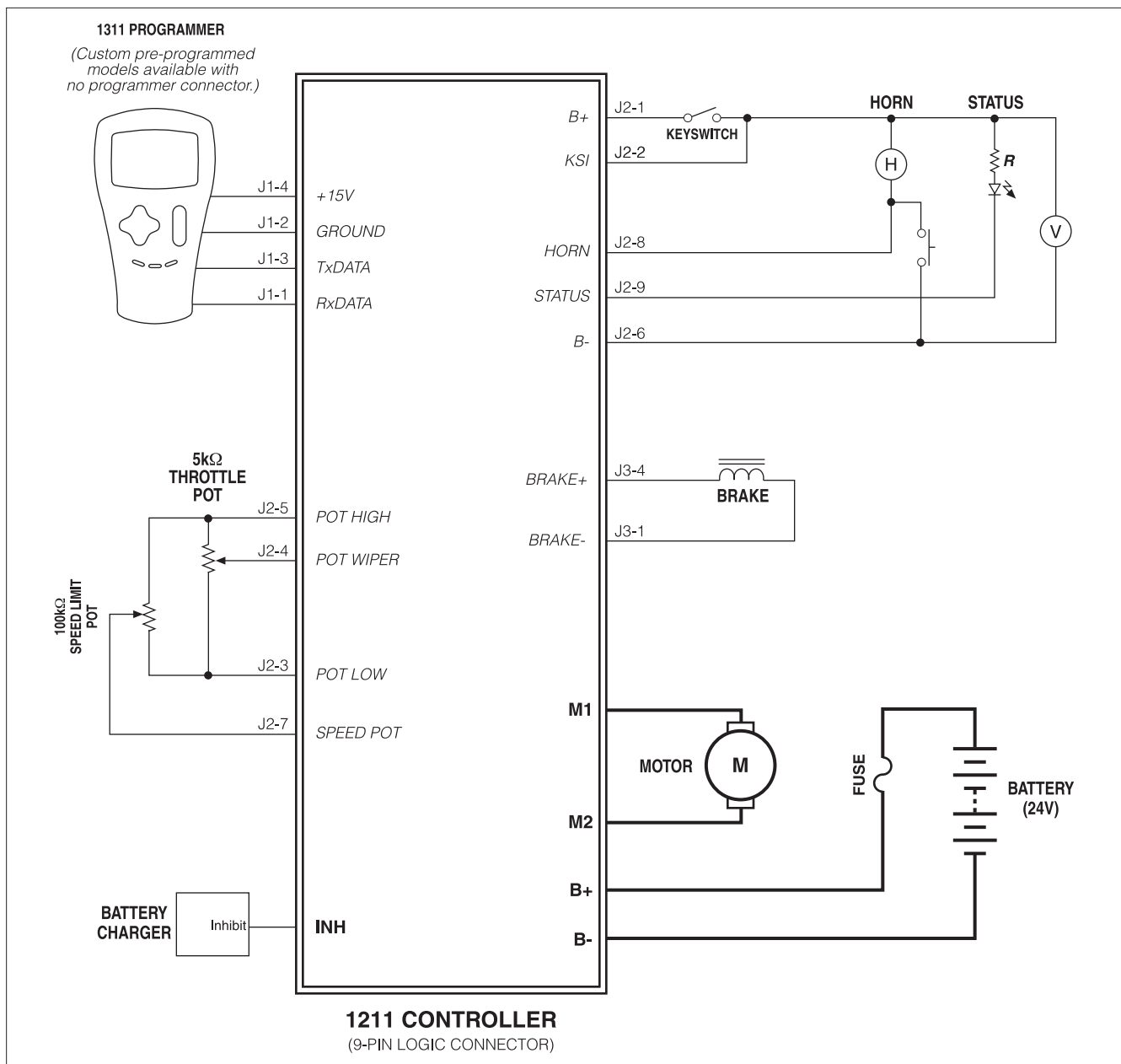

Fig. 5b Standard wiring, Curtis 1211 controller with 9-pin logic connector and speed limit pot at Pin 7.

WIRING: STANDARD INSTALLATION, 9-PIN MODELS (REVERSE-SWITCH OPTION)

The wiring diagram presented in Figure 5c shows a typical installation for controllers with the 9-pin logic connector (J2b) in which Pin 7 is a Reverse Switch input. The Reverse Switch option allows additional throttle types to be used, such as single-ended 3-wire 5kΩ potentiometer throttles or single-ended voltage throttles.

The Horn (Pin 8) provides a reverse beep and also sounds the fault codes in the event of a fault. The Status LED (Pin 9) indicates the state of the controller and also enhances its diagnostic capabilities by flashing fault codes.

Note: An appropriately sized fuse must be included in the power circuit (as shown) to avoid damage to the controller.

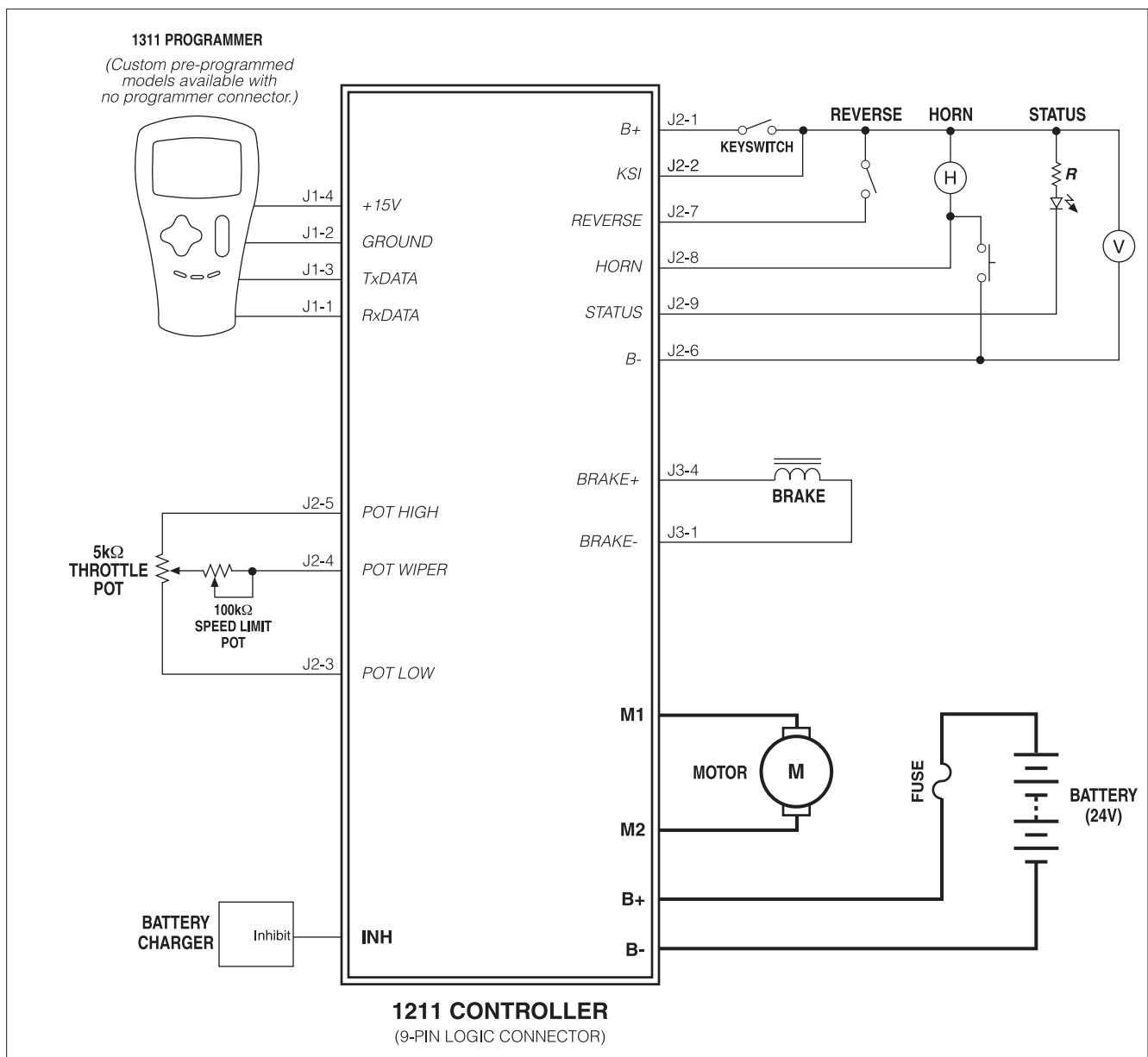

Fig. 5c Standard wiring, Curtis 1211 controller with 9-pin logic connector and reverse switch at Pin 7.

THROTTLE WIRING

The 6-pin controller and the 9-pin TÜV-compliant controller accept a wigwag (or inverse wigwag) signal from either a 3-wire potentiometer throttle or a voltage throttle; see Figures 5a and 5b.

The 9-pin reverse-switch controller additionally accepts signals from single-ended throttles. With single-ended throttles, a Reverse switch must be included in the circuit at Pin 7, as shown in Figure 5c.

5kΩ, 3-Wire Potentiometer

A 5kΩ, 3-wire potentiometer is the standard throttle, and is shown in standard wiring diagrams (Fig. 5a, 5b, 5c) as well as below in Figure 6.

Fig. 6 Wiring for 3-wire, 5kΩ potentiometer throttle.

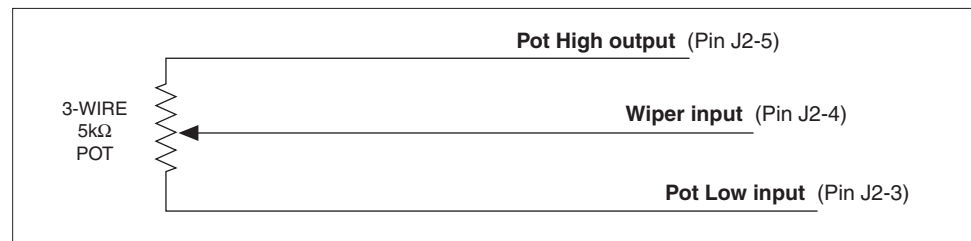

The controller provides full pot fault protection against open or shorted wires anywhere in the throttle assembly. The overall pot resistance can range from 4.5 kΩ to 7 kΩ. Values outside this range will trigger a fault condition. If a pot fault occurs while the vehicle is moving, the controller will decelerate the vehicle to neutral through its normal deceleration curve. If the fault is corrected while the throttle is still applied, the vehicle will accelerate to the requested speed.

The 9-pin controller with a Reverse switch can also accept single-ended signals from this kind of throttle.

Programmable models: For wigwag and inverted wigwag applications, the pot can be correctly centered within the controller's neutral band by using the throttle autocalibration feature (see page 19). Pots with less than 5 kΩ total resistance change over the throttle's full stroke can be accommodated by programming the controller for reduced-range throttle inputs, via the throttle gain parameter (see pages 21 and 22).

5V Throttle

A 5V throttle can also be used, as shown in Figure 7. Depending on your controller model, either a wigwag or a single-ended 5V throttle can be used.

With a wigwag or inverted wigwag input, the throttle output voltage must be 2.5 V (\pm deadband) in neutral and a 4.7kΩ, 0.25W resistor must be added between the pot high and pot low pins. A resistor is not required with a single-ended input.

Because the throttle input voltage is referenced to B- and no throttle connections are made to the pot high and pot low pins, throttle fault protection is lost with 5V throttles. The controller will not recognize out-of-range throttle inputs as faults, and applying excessive voltages to the throttle wiper input may

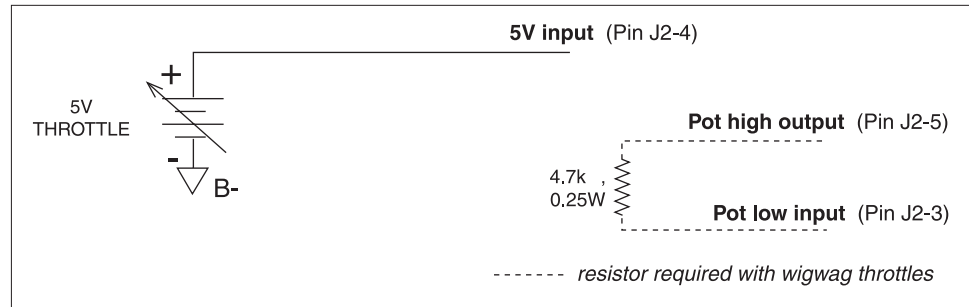
Fig. 7 *Wiring for 5V throttle.*

damage the controller. **It is the responsibility of the vehicle manufacturer to provide throttle fault detection for 5V throttles.**

Programmable models: Voltage throttles with less than 5 V total voltage change over the full stroke can be accommodated by programming the controller for reduced-range throttle inputs, via the throttle gain parameter (see pages 21 and 22).

Speed Limit Pot

A speed limit pot allows the operator to adjust the speed of the vehicle at full throttle. The speed limit pot should be sized so that it does not affect throttle input resistance and thus the throttle response.

Speed limit pot wiring is dependent on the controller model. For 6-pin controllers and for 9-pin controllers with the reverse option, the speed limit pot is wired in series with the throttle pot wiper (see Figures 5a and 5c). With this configuration, the speed limit pot limits the throttle command voltage supplied at the throttle pot wiper input, J2-4. Note: If your application uses a single-ended voltage throttle with the reverse option, wire the speed limit pot in series with the 5V going to the pot wiper (Pin 4).

For TÜV-compliant 9-pin controllers, the speed limit pot is wired in parallel with the throttle pot (see Figure 5b). The speed limit pot wiper is connected to pin J2-7, which provides a separate speed limit input. This configuration allows the throttle to operate throughout its full range and provides accurate fault detection as required by TÜV.

When the speed limit pot is in its max speed position, the vehicle's speed at full throttle corresponds to the set max speed. When it is in its min speed position, the vehicle's speed at full throttle corresponds to the set min speed. On programmable models, the max and mins speeds are adjustable.

SWITCHES AND OTHER HARDWARE

Keyswitch

The vehicle should have a master on/off switch to turn the system off when not in use. The keyswitch provides logic power for the controller and for the other control input switches. It must be sized to carry the 150 mA quiescent logic current plus the current necessary to drive the precharge function (1.5 A for 0.5 seconds) and the horn and any other accessories on the keyswitch circuit.

Horn

The controller is capable of driving a low current dc horn at 1 Hz. On controllers with a 6-pin logic connector, the horn only sounds when the horn button is depressed (see Fig. 5a). On controllers with a 9-pin logic connector (see Fig. 5b, 5c) the horn sounds a warning when the driving in reverse (a series of beep tones) and—on programmable models—when the throttle autocalibration feature is being used (a constant tone).

The horn also beeps the fault codes; see Section 7. The horn driver sinks a maximum current of 15 mA. Using a horn with a higher current requirement will damage and disable the driver.

Inhibit

The inhibit input can be used to inhibit operation during battery charging. The inhibit input overrides all other controller inputs and is active when low (i.e., when shorted to B-). The input can be left floating when not engaged; it does not need to be pulled high. Typically, battery chargers have a dedicated third terminal that automatically provides inhibit. If your battery charger does not have this third terminal, inhibit can be wired as shown in Figure 8.

Fig. 8 Wiring to inhibit vehicle operation during battery charging (for battery chargers without a dedicated inhibit terminal).

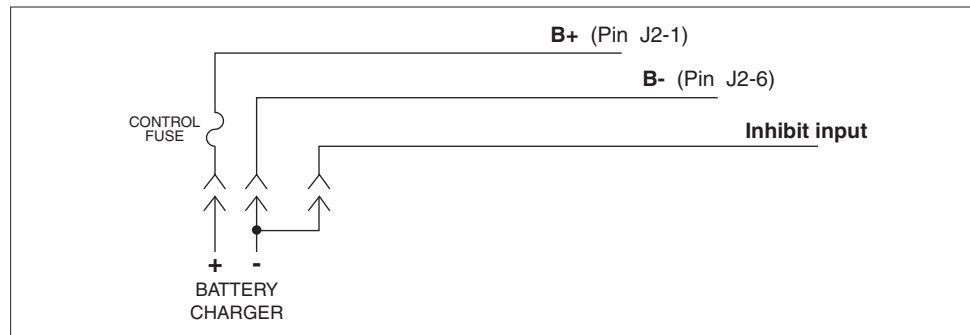

The battery charger should be connected only after the vehicle has come to a complete stop.

Circuitry Protection Device

A fuse is recommended for use in the high power connection from the battery to the controller's B+ terminal. The fuse will protect the power system from external shorts and should be sized appropriately for the controller's rated current.

Status LED (9-pin logic connector models)

The controller has the capability to drive a panel indicator LED, at pin J2b-9. This LED can be used to tell the operator, at a glance, the controller's status; it will also provide diagnostics information via flash codes (see Section 7).

If a Status LED is used, it should be installed with the proper resistor in series. The controller's LED driver is capable of a maximum current of 15 mA. The recommended resistor—designed to limit driver current to 15 mA when active—is 2.4 k Ω , 0.5 W. Alternatively, an LED with a built-in resistor can be used; it should be rated for 24V operation.

3

INSTALLATION CHECKOUT

After you have installed your new controller per Section 2, complete this simple installation checkout.

Unless you have a custom pre-programmed controller, you will first have to determine your motor's resistance using procedure ③ on page 28. After you have programmed the Motor R parameter, continue with the checkout procedure.

1. Put the vehicle up on blocks to get the drive wheels off the ground so they spin freely.
2. Doublecheck all wiring to ensure that it is consistent with the wiring guidelines presented in Section 2. Make sure all connections are tight.
3. Put the throttle in neutral.
4. Turn on the keyswitch. The controller should power up. If it does not, check for continuity in the keyswitch circuit and controller ground.
5. Operate the throttle in the forward and reverse directions; the motor should turn in the selected direction. If it does not, verify the wiring to the throttle and motor. The motor should run proportionally faster with increasing throttle.
6. Take the vehicle down off the blocks and drive it around. Confirm that it is accelerating and braking properly.
7. Plug in the battery charger to verify the Inhibit input status.
8. Verify that all options—such as high pedal disable (HPD), horn, and Status LED—are as intended.

This checkout must be successfully completed before the vehicle is used.

If you have a standard *programmable* 1211 controller, continue on to Section 4: Programming Your Controller.

If your 1211 controller is a custom *pre-programmed* model with a *2-pin* logic connector and no programmer connector, you can now skip directly to Section 7: Diagnostics and Troubleshooting, page 35.

If you have a custom *pre-programmed* model with a *6-pin* logic connector and no programmer connector, skip directly to Section 8: Maintenance, page 38.

4

PROGRAMMABLE PARAMETERS

Programmability is available on the standard 1211 models and on custom models that are equipped with the optional programmer connector (J1). On custom non-programmable models, the parameters described in this section are factory programmed to OEM specifications. On programmable models, the parameters are adjustable by means of the 1311 handheld programmer (or 1314 PC programming station); see Appendix B.



Individual parameters are described in the following text in the order listed here, using the abbreviated names that are displayed in the programmer's Program Menu. Not all of these parameters are displayed on all controllers; the list for any given controller depends on its specifications.

The programmer displays the parameters in a different order. For a list of the individual parameters in the order in which they appear in the Program Menu, see Section 6: Programmer Menus.

Motor Parameters	p. 14
Main Current Limit	
Motor Resistance	
Measure Resistance	
Acceleration Parameters	p. 14
Forward Accel Rate (Max/Min)	
Reverse Accel Rate (Max/Min)	
Braking Parameters	p. 15
Forward Decel Rate (Max/Min)	
Reverse Decel Rate (Max/Min)	
Soft Stop Speed	
Key Off Deceleration	
Brake Delay	
E Stop	
Speed Parameters	p. 17
Forward Speed (Max/Min)	
Reverse Speed (Max/Min)	
Creep Speed	
IR Compensation	
Throttle Parameters	p. 19
Throttle Input Signal Type	
Throttle Autocalibration	
Throttle Deadband	
Throttle Gain	
Ramp Shape	
Fault Parameters	p. 24
High Pedal Disable (HPD)	
Brake Faults	
Fault Beep	
Other Parameters	p. 25
Sleep Delay	
Tremor Compensation	
Reverse Beep	
Beeper Solid	

Motor Parameters

MAIN C/L

The **main current limit** parameter allows adjustment of the maximum current the controller will supply to the motor during both drive and regenerative braking operation. This parameter can be limited to protect the motor from excessive (potentially damaging) currents or to reduce the maximum torque applied to the drive system by the motor. It is adjustable from 4.5 amps up to the controller's full rated current of 30 A or 45 A.

MOTOR R

The **motor resistance** parameter is crucial to proper vehicle operation. The control system performance depends on this value being set correctly. The motor resistance parameter must be set to the actual cold motor resistance. For instructions, see tuning procedure ③, on page 28. Note: The motor resistance parameter is displayed in milliohms.

MEASURE R

The **measure resistance** parameter is used to enable or disable the motor resistance check. When Measure R is programmed On, the controller performs periodic resistance measurements on the motor and compensates for resistance changes related to motor temperature. Measure R should be programmed On for motors with electro-mechanical brakes and programmed Off for non-brake applications.

Acceleration Parameters

FWD ACCEL MAX

The **maximum-speed forward acceleration rate** defines the time it takes the controller to accelerate from zero to 100% output during forward travel at full throttle with the speed limit pot in its maximum speed position (or when no speed limit pot is used). Larger values represent a longer acceleration time and gentler starts, while smaller values represent faster acceleration. The max-speed forward acceleration rate is adjustable from 0.2 to 4.0 seconds; rates under 0.5 second provide abrupt acceleration and should only be used under special circumstances.

The max-speed and min-speed forward acceleration rates are scaled linearly to provide appropriate response throughout the speed limit pot's range.

FWD ACCEL MIN

The **minimum-speed forward acceleration rate** defines the time it takes the controller to accelerate from zero to 100% output during forward travel at full throttle with the speed limit pot in its minimum speed position. Larger values

represent a longer acceleration time and gentler starts, while smaller values represent faster acceleration. The min-speed forward acceleration rate is adjustable from 0.2 to 8.0 seconds; rates under 0.5 second provide abrupt acceleration and should only be used under special circumstances.

REV ACCEL MAX

The **maximum-speed reverse acceleration rate** defines the time it takes the controller to accelerate from zero to 100% output while traveling in reverse at full throttle with the speed limit pot in its maximum speed position (or when no speed limit pot is used). Larger values represent a longer acceleration time and gentler starts, while smaller values represent faster acceleration. The max-speed reverse acceleration rate is adjustable from 0.2 to 8.0 seconds; rates under 0.5 second provide abrupt acceleration and should only be used under special circumstances.

The max-speed and min-speed reverse acceleration rates are scaled linearly to provide appropriate response throughout the speed limit pot's range.

REV ACCEL MIN

The **minimum-speed reverse acceleration rate** defines the time it takes the controller to accelerate from zero to 100% output while traveling in reverse at full throttle with the speed limit pot in its minimum speed position. Larger values represent a longer acceleration time and gentler starts, while smaller values represent faster acceleration. The min-speed reverse acceleration rate is adjustable from 0.2 to 8.0 seconds; rates under 0.5 second provide abrupt acceleration and should only be used under special circumstances.

Braking Parameters

FWD DECEL MAX

The **maximum-speed forward deceleration rate** determines the time it takes the controller to decelerate from its present output to zero when the throttle is released to neutral during forward travel with the speed limit pot in its maximum speed position (or when no speed limit pot is used). Larger values represent a longer deceleration time and gentler stops. Smaller values reduce the stopping distance required. The max-speed deceleration rate should be set at a value that will ensure the vehicle stops within a safe distance when traveling at full speed. The max-speed deceleration rate is adjustable from 0.2 to 4.0 seconds; rates under 0.5 second provide abrupt stops and should only be used under special circumstances.

FWD DECEL MIN

The **minimum-speed forward deceleration rate** defines the time it takes the controller to decelerate from its present output to zero when the throttle is re-

leased to neutral during forward travel with the speed limit pot in its minimum speed position. Larger values represent a longer deceleration time and gentler stops. Smaller values will reduce the stopping distance required. The min-speed deceleration rate is adjustable from 0.2 to 8.0 seconds; rates under 0.5 second provide abrupt stops and should only be used under special circumstances.

REV DECEL MAX

The **maximum-speed reverse deceleration rate** defines the time it takes the controller to decelerate from its present output to zero when the throttle is released to neutral during reverse travel with the speed limit pot in its maximum speed position (or when no speed limit pot is used). Larger values represent a longer deceleration time and gentler stops. Smaller values will reduce the stopping distance required. This rate should be set at a value that will ensure the vehicle stops within a safe distance when traveling in reverse at full speed. This rate is adjustable from 0.2 to 4.0 seconds; rates under 0.5 second provide abrupt stops and should only be used under special circumstances.

REV DECEL MIN

The **minimum-speed reverse deceleration rate** defines the time it takes the controller to decelerate from its present output to zero when the throttle is released to neutral during reverse travel with the speed limit pot in its minimum speed position. Larger values represent a longer deceleration time and gentler stops. Smaller values will reduce the stopping distance required. This rate is adjustable from 0.2 to 8.0 seconds; rates under 0.5 second provide abrupt stops and should only be used under special circumstances.

SOFT STOP SPD

The **soft stop speed** parameter is used in conjunction with the deceleration parameters and results in a more gradual and smooth stop. The range is adjustable from 0–30% and represents a percentage of maximum speed. Higher values will start a gradual stop sooner, while lower values will start the gradual stop closer to zero speed. A zero value disables the feature and the decel rate is then solely dependent on the decel settings.

KEY OFF DECEL

The **key-off deceleration rate** defines the time it takes the vehicle to stop after the keyswitch has been turned off while the vehicle is in motion. The key-off deceleration rate is independent of the normal programmed deceleration rate and the speed and direction of travel when KSI is switched off. It is adjustable from 0.2 to 4.0 seconds.

BRAKE DELAY

The **brake delay** parameter specifies when the controller engages the electromagnetic brake after the vehicle's speed command has reached zero. This time delay is adjustable from 0.0 to 1.0 seconds. It should be set low enough to minimize rolling downhill when stopping on ramps, yet long enough to allow for a smooth stop on flat surfaces.

The brake delay does not apply in situations where an incline causes the vehicle to change direction after the throttle command has been zeroed. In this case, the controller will detect the “rollback” and engage the electromagnetic brake immediately.

E STOP

The **emergency stop deceleration rate** defines the time it takes the vehicle to stop when a reverse throttle command is given while the vehicle is moving forward. This gives the operator a way to stop more quickly when unexpected conditions arise. When the E Stop feature is invoked the E Stop deceleration rate becomes the new forward deceleration rate. Therefore it makes sense to set it to a value lower (faster stop) than the fastest forward deceleration rate (Fwd Decel Max). The E Stop deceleration rate is adjustable from 0.2 to 4.0 seconds.

Speed Parameters

FWD MAX SPD

The **maximum forward speed** parameter defines the maximum allowed speed at full forward throttle with the speed limit pot in its maximum speed position (or when no speed limit pot is used). For example, if Forward Maximum Speed is set at 60% and the speed limit pot is in its maximum speed position, the controller will adjust its output to achieve 60% speed at full throttle.

FWD MIN SPD

The **minimum forward speed** parameter defines the maximum allowed speed at full forward throttle with the speed limit pot in its minimum speed position. For example, if Forward Minimum Speed is set at 20% and the speed limit pot is in its minimum speed position, the controller will adjust its output to achieve 20% speed at full throttle. The minimum speed cannot be set higher than the programmed maximum speed.

REV MAX SPD

The **maximum reverse speed** parameter defines the maximum allowed speed in reverse at full throttle with the speed limit pot in its maximum speed position

(or when no speed limit pot is used). For example, if Maximum Reverse Speed is set at 40% and the speed limit pot is in its maximum speed position, the controller will adjust its output to achieve 40% reverse speed at full throttle.

REV MIN SPD

The **minimum reverse speed** parameter defines the maximum allowed speed in reverse at full throttle with the speed limit pot in its minimum speed position.

IR COMP COEFF

IR compensation is a method by which the controller maintains a constant vehicle speed despite changes in motor loading. The **IR compensation** parameter adjusts how aggressively the controller tries to maintain constant speed under changing load conditions. The parameter is scaled 0–100%, and defines the percentage of compensation applied.

Throttle Parameters

THRTL TYPE

The controller can be programmed to accept single-ended, wigwag, or inverted wigwag signals from a 5k Ω , 3-wire pot or from a 5V throttle, depending on the model.

The **throttle input signal type** options—Types “0” through “5” in the Throttle Type programming menu—are listed in Table 1.

Note that Types 2 through 5 are only applicable to controllers with the 9-pin logic connector (**J2b**), and require a reverse switch in the circuit.

THROTTLE TYPE	APPLICABILITY		DESCRIPTION
	5k Ω 3-wire Pot	5V Throttle	
0	✓	✓	wigwag pot or voltage throttle
1	✓	✓	inverted wigwag pot or voltage throttle
2	✓		single-ended pot; maximum speed = 5k Ω
3	✓		inverted single-ended pot; maximum speed = 0
4		✓	single-ended voltage throttle; maximum speed = 5V
5		✓	inverted single-ended voltage throttle; maximum speed = 0

THRTL AUTOCAL

The **throttle autocalibration** parameter provides a means of easily and reliably centering wigwag throttle pots. To use this method, a horn must be connected to the horn driver. The controller inhibits driving while in autocalibration mode, enabling the throttle potentiometer to be adjusted safely.

Throttle centering is accomplished as follows:

1. Jack the vehicle drive wheels off the ground or disconnect the motor leads.
2. Completely assemble the throttle mechanism but do not tighten the clamping mechanism that secures the potentiometer shaft to the throttle lever.
3. Plug the programmer into the controller, and turn on the key-switch.
4. Select the Program mode and scroll down to the throttle autocalibration parameter.
5. Set the throttle autocalibration to On. At this point, the horn will probably sound, indicating that the throttle pot is out of adjust-

- ment. If the horn does not sound, the pot is already centered and further adjustment is not necessary.
6. With the throttle lever at the neutral position, adjust the potentiometer in one direction until the horn turns off. Note this position. Adjust the pot in the other direction until the horn turns off. Note this position. Set the pot halfway between the two noted positions. The pot is now adjusted to the proper value for neutral.
 7. Tighten the clamping mechanism that secures the throttle lever to the potentiometer shaft. Depress and release the throttle to verify the mechanical return to neutral; the horn should turn off with the same amount of motion in both directions.
 8. Set the throttle autocalibration parameter to Off, or cycle the keyswitch to reset it to Off. (If you are performing the reset by cycling the keyswitch, note that KSI must remain off for at least 4 seconds.) The vehicle will not drive if the throttle autocalibration parameter is left On.

THRTL DEADBAND

The **throttle deadband** parameter defines the throttle pot wiper voltage range that the controller interprets as neutral. Increasing the throttle deadband setting increases the neutral range. This parameter is especially useful with throttle assemblies that do not reliably return to a well-defined neutral point, because it allows the deadband to be defined wide enough to ensure that the controller goes into neutral when the throttle mechanism is released.

Examples of two deadband settings (25%, 10%) are shown below in Figure 9, along with the equations used to determine the wiper voltage range (with respect to B-) that the controller will interpret as neutral.

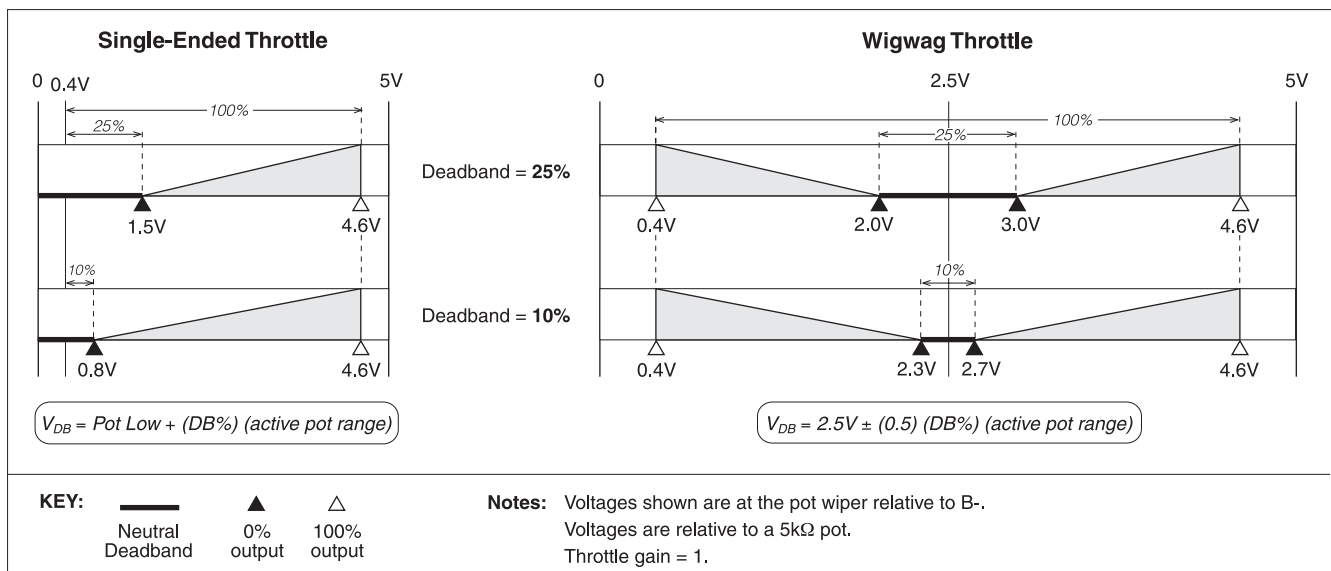

Fig. 9 Effect of adjusting the throttle deadband parameter.

The programmer displays the throttle deadband parameter as a percentage of the wiper voltage range and is adjustable from 6.0% to 25.0%. The default deadband setting is 10.0%.

The throttle wiper voltage range is approximately 4 volts, measured relative to B-. This is true regardless of whether a single-ended or wigwag throttle is used. When a single-ended throttle is used, the deadband parameter sets a single threshold wiper voltage—that is, a wiper voltage (relative to B-) at which the controller will begin to modulate. When a wigwag throttle is used, the deadband parameter sets two threshold wiper voltages, one on either side of the 2.5 V centerpoint, for forward and reverse.

Depending on the individual pot, the values for Pot Low and Pot High (and hence for the deadband, which is a percentage of the range defined by Pot Low and Pot High) vary. The values listed below can be used with the equations provided in Figure 9 to calculate the actual deadband threshold(s) for any given deadband setting:

POT	POT LOW	POT HIGH	POT RANGE
4 k Ω	0.5 V	4.5 V	4.0 V
5 k Ω	0.4 V	4.6 V	4.2 V
7 k Ω	0.3 V	4.7 V	4.4 V

Detailed guidelines for adjusting the throttle deadband parameter are presented in Section 5, page 20.

THRTL GAIN

The **throttle gain** parameter sets the wiper voltage required to produce 100% controller output. Increasing the throttle gain setting reduces the wiper voltage required, and therefore the full stroke necessary to produce full output is reduced. This feature allows reduced-range throttle assemblies to be used.

Examples are shown in Figure 10 to illustrate the effect of three different throttle gain settings (1, 1.5, and 2) on full-stroke wiper voltage. Adjusting the throttle gain also affects the neutral deadband, which is a percentage of the throttle's active range. Note: The deadband values shown in the bottom two examples are the same due to rounding; the actual deadband in the bottom example is somewhat narrower than in the example above it.

When a single-ended throttle is used, the throttle gain parameter sets the maximum pot wiper voltage required to produce 100% output. When a wigwag throttle is used, the throttle gain parameter sets the pot wiper resistance required to produce 100% output in both forward and reverse: the wiper voltage required for full forward output is decreased, and the wiper voltage required for full reverse output is increased.

The throttle gain parameter can be set with values from 1.0 to 10.0. The throttle gain value is the ratio of the pot's full 5k Ω to the resistance of the throttle's range of travel ($G = R_{\text{POT}} / R_{\text{TRAVEL}}$). A setting of 1.0 thus represents

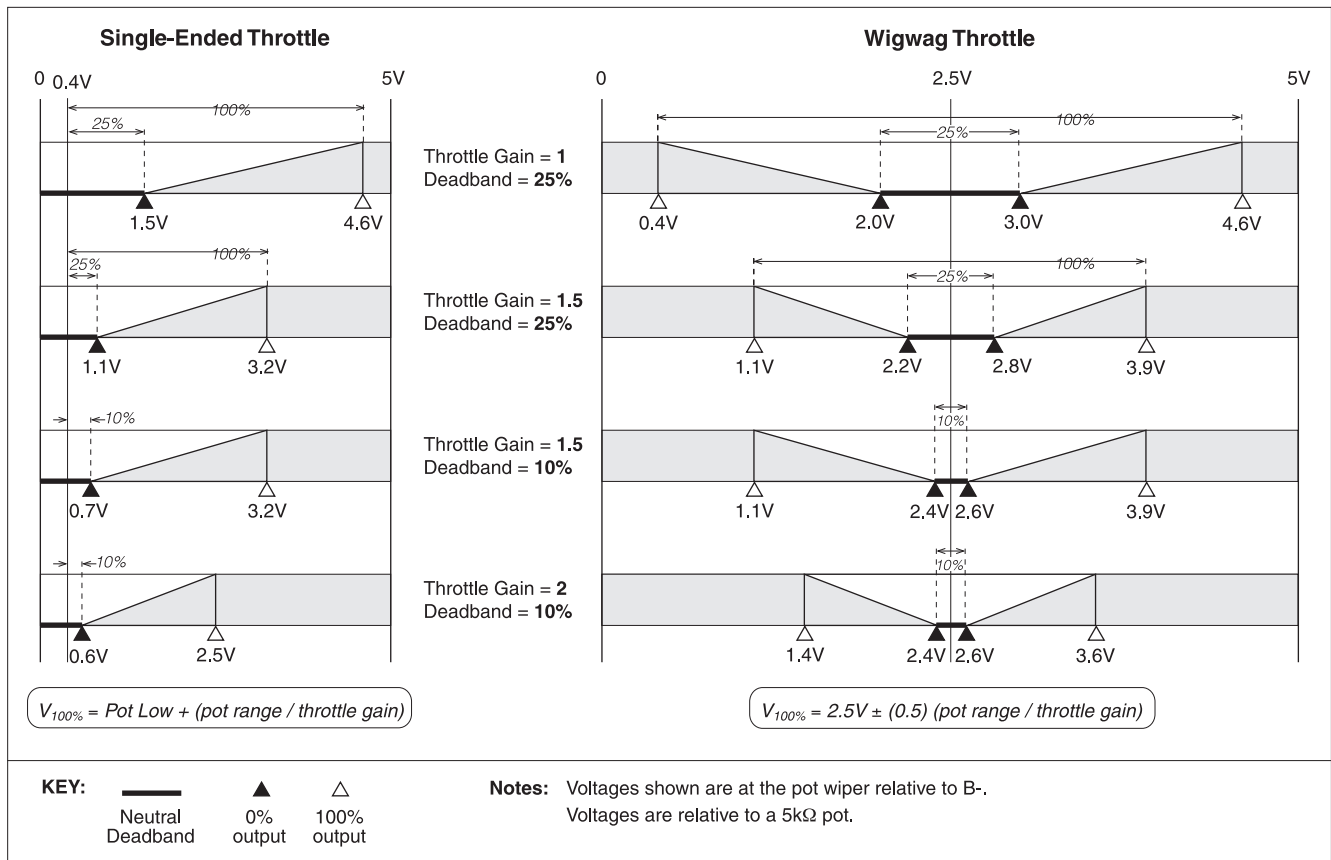

Fig. 10 Effect of adjusting the throttle gain parameter.

a one-to-one ratio—in other words, no throttle gain adjustment. A setting of 10.0 would allow use of a pot with a range of only 1/10th of 5kΩ, i.e., 500 ohms. For most applications, throttle gain settings between 1.0 and 2.0 will work best.

Note: The throttle characteristics are defined in terms of wiper voltage rather than throttle pot resistance because of the range of pot values that can be used and the variation between pots of the same value.

Detailed guidelines for adjusting the throttle gain parameter are presented in Section 5, page 21.

RAMP SHAPE

The **ramp shape** parameter determines the static throttle map of the controller. This parameter modifies the throttle input to the controller, and hence the vehicle's response. Setting the ramp shape parameter at 50% provides a linear response to throttle position. Values below 50% reduce the throttle command at low throttle positions, providing enhanced slow speed maneuverability. Values above 50% give the vehicle a faster, jumpier feel at low throttle positions.

The ramp shape can be programmed to values between 20.0% and 70.0%. The ramp shape number refers to the throttle command at half throttle. For example, if maximum speed is set at 100%, a ramp shape of 40% will result

in a 40% throttle command at half throttle. The 50% ramp shape corresponds to a linear response. Six ramp shapes (20, 30, 40, 50, 60, and 70%) are shown as examples in Figure 11.

Fig. 11 Ramp shape (throttle map) with maximum speed set at 100%.

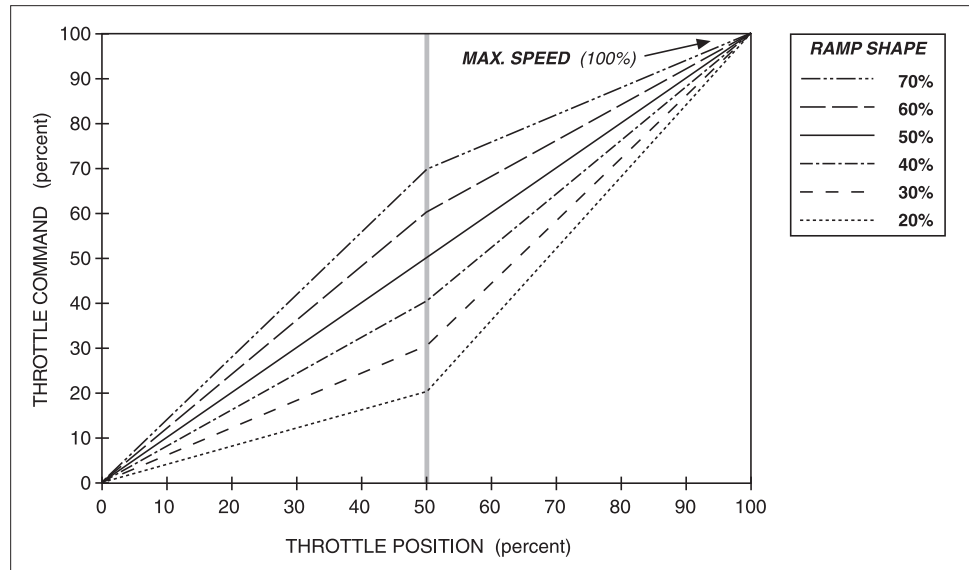

Changing the maximum speed setting changes the throttle command range, and hence the ramp shape. Ramp shapes with the maximum speed setting dropped from 100% to 60% are shown in Figure 12.

Fig. 12 Ramp shape (throttle map) with maximum speed set at 60%.

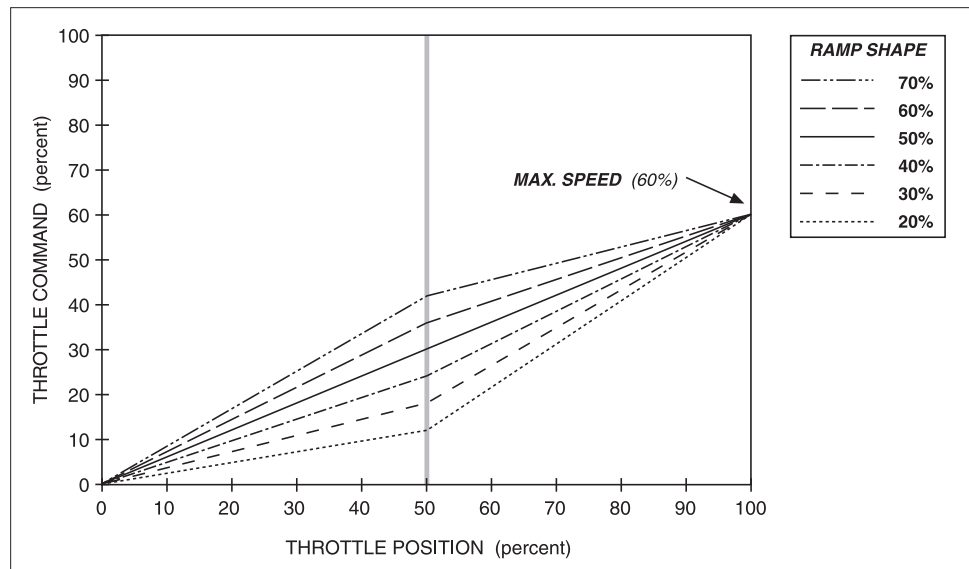

In all cases, the ramp shape number is the throttle command at half throttle. In Figure 12, for example, the 50% ramp shape results in a 30% throttle command at half throttle (i.e., a command that is halfway between 0% and 60%). The 20% ramp shape results in a 12% command at half throttle (20% of the range from 0% to 60%).

Fault Parameters

HIGH PEDAL DIS

The primary function of the **high pedal disable (HPD)** feature is to prevent the vehicle from moving if the controller is turned on with the throttle already applied. HPD also serves as the interlock to prevent the vehicle from starting up with the inhibit feature active, and to prevent driving if Inhibit is activated during operation.

When the HPD parameter is programmed On, HPD is active and controller output is inhibited (1) if a throttle input greater than the throttle deadband exists when the controller is turned on, (2) if the inhibit feature is active when the controller is turned on, or (3) if inhibit is activated while the vehicle is being driven. If HPD is programmed Off, this protection feature is disabled. Note: All DME scooter applications must have the HPD feature programmed On to satisfy the industry's safety requirements.

BRAKE FLTS

The **brake faults** parameter enables ("On") or disables ("Off") all the electromagnetic brake driver and wiring fault detection. All DME scooter applications must have this parameter programmed On to satisfy the industry's safety requirements.

In non-DME applications such as sweeper/scrubbers, where there is no electromagnetic brake, the brake faults parameter can be programmed Off, thus eliminating the need for the 200 Ω , 5W bias resistor on the controller's brake driver output that would otherwise be necessary.

FAULT BEEP (*9-pin models*)

The **fault beep** parameter enables the horn during controller faults, in order to make the fault codes audible. It beeps only the fault codes; it does not precede the fault code with a level-of-seriousness code (as does the Status LED, with its slow/fast flash preceding the fault code). If this audible alarm is not wanted, the fault beep parameter should be programmed Off.

Other Parameters

SLEEP DLY

The controller powers down completely if the throttle request remains at neutral beyond the time specified by the **sleep delay** parameter; to resume operation, the keyswitch must be cycled. The sleep delay can be set from 0 to 60 minutes. Setting this parameter to zero disables the sleep delay.

TREMOR COMP

The **tremor compensation** parameter allows adjustment to limit the controller's response to sharp throttle movements, such as movements resulting from hand tremors. The tremor compensation parameter can be set to values of 1 through 5, with 1 providing no compensation, and 5 providing the most. Although larger values provide steadier response, they also result in more sluggish response to throttle requests. There is thus a trade-off between crispness of response (low tremor compensation settings) and steady speed in the presence of tremors (high tremor compensation settings).

The effect of tremor compensation is most noticeable when the throttle is moved quickly from full to very low requests. Note: this function is bypassed if the throttle moves into the neutral deadband.

Although designed primarily to help end users with hand tremor problems, this parameter can be used more generally to smooth out overall vehicle responsiveness for steadier driving.

REV BEEP (*9-pin models*)

The **reverse beeper** parameter enables the horn when the vehicle is traveling in reverse. If this audible warning is not wanted, the reverse beeper parameter should be programmed Off.

BEEPER SOLID (*9-pin models*)

The **beeper solid** parameter controls the output of the reverse beeper. When programmed On, the horn will sound continuously when the vehicle is traveling in reverse. When programmed Off, the horn will sound at a fixed frequency in reverse; the frequency is similar to the “beep, beep, beep” often heard on industrial vehicles when they are backing up.

5

TUNING YOUR CONTROLLER

(PROGRAMMABLE MODELS ONLY)

Before tuning your controller, be sure to complete the installation checkout that was presented on page 12.

The 1211 controller is a very powerful vehicle control system. Its wide variety of adjustable parameters allow many aspects of vehicle performance to be optimized. Once a vehicle/motor/controller combination has been tuned, the parameter values can be made standard for that system or vehicle model. Any changes in the motor, the vehicle drive system, or the controller will require that the system be tuned again to provide optimum performance.

The tuning procedures should be conducted in the sequence given, because successive steps build upon the ones before. It is important that the effect of these programmable parameters be understood in order to take full advantage of the 1211 controller's powerful features. Please refer to the descriptions of the applicable parameters in Section 4 if there is any question about what any of them do.

If you find a problem during the programming process, refer to the diagnostics and troubleshooting section (Section 7) for further information.

① Beginning the tuning procedures

①-a. **Jack the vehicle drive wheels up off the ground so they spin freely.**

①-b. Put the throttle in neutral. If your application has a reverse switch, make sure it is open.

①-c. Turn on the controller and plug in the programmer. The programmer should power up with an initial display, and the Status LED (if your application has one) should light steadily. If neither happens, check for continuity in the keyswitch circuit and controller ground.

② Throttle

Put the programmer into Program mode, and set the Throttle Type parameter to match the throttle you are using (Type 0–5); see page 19.

It is important to ensure that the controller output is operating over its full range. The following tuning procedures will establish the throttle deadband and throttle gain parameter values that correspond to the absolute full range of your particular throttle mechanism.* It is advisable to include some buffer around the absolute full range of the throttle mechanism to allow for throttle resistance variations over time and temperature as well as variations in the tolerance of potentiometer values between individual throttle mechanisms.

* If you are using a wigwag throttle, you should center it before proceeding with the throttle tuning procedures. Instructions for wigwag throttle centering (using the Throttle Autocalibration parameter) are presented on page 19.

Tuning the Throttle Deadband

②-a. Select the Monitor Menu. The Throttle % field should be visible in the display. You will need to reference the value displayed here.

②-b. Slowly apply the throttle until you hear the electromagnetic brake disengage. Use care with this step as it is important to identify the threshold throttle position at which the brake is disengaged.

②-c. Without moving the throttle, read the value shown in the Throttle % field. This value should be zero. If the Throttle % value is zero, proceed to Step ②-d. If it is greater than zero, the throttle deadband parameter must be increased. Select the Program Menu, scroll down to display the THRTL DEADBAND field, and enter a larger THRTL DEADBAND value. Select the Monitor Menu and repeat the procedure from Step ②-b until the Throttle % is zero at the electromagnetic brake disengagement point.

②-d. While observing the Throttle % value displayed in the programmer's Monitor Menu, continue to increase the throttle past the electromagnetic brake disengagement point. Note where the Throttle % value begins to increase, indicating that the controller has begun to supply drive power to the motor. If the throttle had to be moved further than desired before the Throttle % value began to increase, the throttle deadband parameter must be decreased. In the Program Menu, scroll down to the THRTL DEADBAND field, and enter a smaller THRTL DEADBAND value. Select the Monitor Menu and repeat the procedure from Step ②-b. When the amount of travel between the point at which the brake is disengaged and the Throttle % value begins to increase is acceptable, the throttle deadband is properly tuned.

②-e. If a bidirectional (wigwag) throttle assembly is being used, the procedure should be repeated for the reverse direction. The THRTL DEADBAND value should be selected such that the throttle operates correctly in both forward and reverse.

Tuning the Throttle Gain

②-f. Apply full throttle and observe the Throttle % value. This value should be 100%. If it is less than 100%, the throttle gain must be increased to attain full controller output at the maximum throttle position. Select the Program Menu, scroll down to the THRTL GAIN field, and enter a larger THRTL GAIN value. Select the Monitor Menu and repeat this step until the Throttle % value is 100%.

②-g. Now that the full throttle position results in a 100% value for Throttle %, slowly reduce throttle until the Throttle % value drops below 100% and note the throttle position. This represents the extra range of motion allowed by the throttle mechanism. If this range is large, you may wish to decrease it by decreasing the throttle gain. This will provide a larger active throttle range and more vehicle control. Select the Program Menu, scroll down to the THRTL GAIN field, and enter a smaller THRTL GAIN value. Select the Monitor Menu and repeat this step until an appropriate amount of extra range is attained.

②-h. If a wigwag throttle is being used, repeat the procedure for the reverse direction. The THRTL GAIN value should be selected such that the throttle operates correctly in both forward and reverse.

Confirming proper throttle operation

Select a direction and operate the throttle. The motor should begin to turn in the selected direction. If it does not, verify the wiring to the throttle and motor. The motor should run proportionally faster with increasing throttle.

③ Determining motor resistance

If your motor does not have an electromechanical brake, set the MEASURE R parameter Off before conducting this procedure; you should leave it Off permanently.

If the cold resistance of the traction motor in your application is known, you can enter this value, in milliohms, for the motor resistance (MOTOR R) parameter, and proceed to Step ④. However, we strongly recommend that instead of using the theoretical value provided by the motor manufacturer you use the actual value as determined in the following procedure. It is very important that the motor resistance parameter be set accurately. The correct value for MOTOR R is determined as follows.

③-a. Position the vehicle up against a wall, high curb, or some other immovable object.

③-b. Plug the programmer into the controller and turn on the keyswitch.

③-c. In the programmer's Program Menu, set the MAIN C/L parameter to "15" (15 amps).

③-d. In the Monitor Menu, scroll down to display the Motor R field.

③-e. With the speed limit pot set at maximum, apply the throttle full forward, driving the vehicle against the immovable object, so as to stall the motor.

Use caution: Apply the throttle only long enough for the Motor R reading to stabilize.

③-f. Observe the Motor R value displayed in the Monitor Menu.

③-g. Select the Program Menu, where MOTOR R will appear near the top of the display. Program the MOTOR R parameter to the Motor R value that was displayed in the Monitor Menu.

③-h. Before moving on to Step ④, be sure to set the MAIN C/L back to its default setting.

④ Setting the maximum speeds

The maximum allowed forward and reverse speed with the speed limit pot in its maximum speed position are set by the maximum speed parameters:

FWD MAX SPD

REV MAX SPD

The maximum speed parameters are programmed as a percentage of the maximum possible speed. Set each of the maximum speed parameters to give the desired performance.

If your application uses the TUV-compliant controller and has a speed limit pot wired in parallel as shown in Figure 3b, set the minimum speed parameters:

FWD MIN SPD
REV MIN SPD

Like the maximum speed parameters, the minimum speed parameters are programmed as a percentage of the maximum possible speed. Set each of the minimum speed parameters to give the desired performance.

⑤ **Setting the acceleration and deceleration rates**

The acceleration and deceleration functions have been designed to provide smooth throttle response when maneuvering at low speeds and snappy throttle response when traveling at high speeds. This is accomplished by defining acceleration/deceleration rates at each end of the speed limit pot's range. The rates are scaled linearly between these two endpoints. Four pairs of parameters define the endpoints of the acceleration/deceleration curves:

Forward acceleration:	FWD ACCEL MIN and FWD ACCEL MAX
Forward deceleration:	FWD DECEL MIN and FWD DECEL MAX
Reverse acceleration:	REV ACCEL MIN and REV ACCEL MAX
Reverse deceleration:	REV DECEL MIN and REV DECEL MAX.

Tuning the rates under the most extreme (slowest, fastest) conditions will most likely result in good performance throughout the entire driving range.

Forward acceleration and deceleration rates

- ⑤-a. First, set the FWD ACCEL MIN. Set the speed limit pot to its minimum speed position. For low speed testing, we suggest that you drive in a confined area such as an office, where low speed maneuverability is crucial. Depending on how you liked the forward acceleration you experienced, increase or decrease the FWD ACCEL MIN value from its default setting. Smaller values provide faster response. Continue testing and adjusting this value until you are satisfied with the vehicle's low speed forward acceleration behavior.
- ⑤-b. Now adjust FWD DECEL MIN, the low speed forward deceleration characteristic. Driving at full throttle with the speed limit pot still in its minimum speed position, release the throttle to neutral. Depending on how you liked the deceleration you experienced, increase or decrease the FWD DECEL MIN value from its default setting. Smaller values provide faster response. Continue testing and adjusting this value until you are satisfied with the vehicle's low speed forward deceleration behavior.
- ⑤-c. Next, set the FWD ACCEL MAX. Set the speed limit pot to its maximum speed position. Apply full throttle. Depending on how

you liked the forward acceleration you experienced, increase or decrease the FWD ACCEL MAX value from its default setting. Smaller values provide faster response. Continue testing and adjusting this value until you are satisfied with the vehicle's high speed forward acceleration.

- ⑤-d. Driving at full throttle with the speed limit pot still in its maximum speed position, release the throttle to neutral. Depending on how you liked the deceleration you experienced, increase or decrease the FWD DECEL MAX value from its default setting. Smaller values provide faster response. Continue testing and adjusting this value until you are satisfied with the vehicle's high speed forward deceleration behavior.

Reverse acceleration and deceleration rates

- ⑤-e. First, set the REV ACCEL MIN. Set the speed limit pot to its minimum speed position. For low speed testing, we suggest that you drive in a confined area such as an office, where low speed maneuverability is crucial. Depending on how you liked the acceleration you experienced while driving in reverse, increase or decrease the REV ACCEL MIN value from its default setting. Smaller values provide faster response. Continue testing and adjusting this value until you are satisfied with the vehicle's low speed reverse acceleration behavior.
- ⑤-f. Now adjust REV DECEL MIN, the low speed reverse deceleration characteristic. Leaving the speed limit pot in its minimum speed position, drive in reverse at full throttle and then release the throttle to neutral. Depending on how you liked the deceleration you experienced, increase or decrease the REV DECEL MIN value from its default setting. Smaller values provide faster response. Continue testing and adjusting this value until you are satisfied with the vehicle's low speed reverse deceleration behavior.
- ⑤-g. Next, set the REV ACCEL MAX. Set the speed limit pot to its maximum speed position. Driving in reverse, apply full throttle. Depending on how you liked the reverse acceleration you experienced, increase or decrease the REV ACCEL MAX value from its default setting. Smaller values provide faster response. Continue testing and adjusting this value until you are satisfied with the vehicle's high speed reverse acceleration.
- ⑤-h. Leaving the speed limit pot in its maximum speed position, drive in reverse at full throttle and then release the throttle to neutral. Depending on how you liked the deceleration you experienced, increase or decrease the REV DECEL MAX value from its default setting. Smaller values provide faster response. Continue testing and adjusting this value until you are satisfied with the vehicle's high speed reverse deceleration behavior.

Fine tuning the acceleration and deceleration rates

- ⑤-i. Drive around while varying the position of the throttle and the speed limit pot. In most cases, setting the acceleration and deceleration rates as described in Steps ⑤-a through ⑤-h will provide good performance throughout. However, you may want to make further adjustments.
- ⑤-j. In rare cases, it may be desirable to adjust the RAMP SHAPE parameter. This parameter can be used, for example, to extend the throttle's gentle acceleration range to further enhance maneuverability in confined areas. See page 22 for a detailed description of the ramp shape options.

Emergency stop deceleration rate

The E STOP function is invoked when the vehicle is moving forward and the throttle makes a fast transition through neutral to a >80% reverse throttle request. This provides a way to stop more quickly when unexpected conditions arise. When the E STOP function engages, its programmed value becomes the new forward deceleration rate, replacing the regular forward deceleration rate.

- ⑤-k. Drive fast and suddenly release the throttle. You will experience the deceleration behavior determined by the forward deceleration rate.
- ⑤-l. Return to fast speed operation, and this time throw the throttle into >80% reverse. Now you are experiencing the deceleration behavior determined by the E STOP rate.
- ⑤-m. Adjust the E STOP value to produce the desirable “feel” for emergency stops: typically as fast as possible without making the vehicle unstable.
- ⑤-n. Note that the E STOP rate should always be faster than (or equal to) the fastest forward deceleration rate, FWD DECEL MAX.

⑥ Adjusting load compensation

The IR COMP COEFF parameter is used to set the percentage of the maximum motor resistance that will be applied, i.e., $(\text{IR COMP COEFF}) \times (\text{MOTOR R})$, to compensate for increased load caused by uneven terrain.

The trade-off in setting this parameter is that as ability to overcome load disturbances increases, operating smoothness decreases. A high IR COMP COEFF value will allow the vehicle to continue creeping at a low speed, even though it has just contacted a bump in the threshold of a doorway. But if IR COMP COEFF is set too high, it may make the vehicle “jumpy” during normal driving. Small throttle movements in this case may no longer provide gentle linear acceleration, but instead initiate accelerations with a sharp jerk. Therefore, the tuning

goal is a balance between adequate load disturbance response and normal acceleration/deceleration response.

The normal range for IR COMP COEFF is approximately 50–80%. Larger numbers provide stiffer, stronger response. If the value needs to be much larger or smaller than this range to achieve acceptable performance, the MOTOR R has probably not been set up correctly and should be checked. Note: Largely different settings for IR COMP COEFF will affect the maximum speeds that were set in Step ④. Therefore, if you make large changes to IR COMP COEFF, you should repeat Step ④.

Assuming that MOTOR R is set correctly (within 10–20%), some general rules of thumb apply:

- ⑥-a. If the vehicle rolls the other direction near the end of a stop on flat ground, IR COMP COEFF is set too high.
- ⑥-b. If the vehicle seems to decelerate to a stop in a nonlinear fashion, IR COMP COEFF could be set too high.
- ⑥-c. If the vehicle is extremely “jumpy” (i.e., responds abruptly to small throttle changes, IR COMP COEFF could be set too high.
- ⑥-d. If the vehicle is still moving on a modest ramp when the brake gets set, IR COMP COEFF is set too low.
- ⑥-e. If the vehicle speed varies dramatically when cresting a hill, IR COMP COEFF is most likely set too low.

⑦ **Adjusting tremor compensation**

The TREMOR COMP parameter controls vehicle response to sharp throttle movements, such as those resulting inadvertently from hand tremors. This parameter can be set from 1–5, with larger values providing steadier response. Generally, we recommend that you do all your tuning with the TREMOR COMP parameter set to 4 and then either leave it at 4 or adjust it down to 3 or up to 5 as the final piece of tuning. Tremor compensation is most noticeable when the throttle is moved quickly from full to small (but non-neutral) values. The function is bypassed in the neutral state to ensure responsive linear deceleration when the driver commands a stop.

6

PROGRAMMER MENUS

The 1311 and 1314 Curtis programmers allow you to program, test, and diagnose Curtis programmable controllers. For information about programmer operation, see Appendix B.

1211 PROGRAM MENU *(not all items available on all controllers)*

MAIN C/L	Main current limit for drive and regen braking, in amps
MOTOR R	Cold resistance of motor, in milliohms
MEASURE R	Motor resistance check: On/Off
IR COMP COEFF	IR compensation factor: 0–100%
TREMOR COMP	Tremor compensation: 1–5
FWD ACCEL MAX	Acceleration rate at maximum throttle requests, in seconds
FWD ACCEL MIN	Acceleration rate at minimum throttle requests, in seconds
FWD DECEL MAX	Deceleration rate at maximum throttle requests, in seconds
FWD DECEL MIN	Deceleration rate at minimum throttle requests, in seconds
SOFT STOP SPD	Speed at which softened stop begins during decel, as % max
REV ACCEL MAX	Reverse accel rate at maximum throttle requests, in seconds
REV ACCEL MIN	Reverse accel rate at minimum throttle requests, in seconds
REV DECEL MAX	Reverse decel rate at maximum throttle requests, in seconds
REV DECEL MIN	Reverse decel rate at minimum throttle requests, in seconds
KEY OFF DECEL	Deceleration rate when keyswitch is turned off, in seconds
E STOP	Emergency deceleration rate, in seconds
FWD MAX SPD	Max. speed with speed pot at max, as % available
FWD MIN SPD	Max. speed with speed pot at min, as % available
REV MAX SPD	Max. reverse speed with speed pot at max, as % available
REV MIN SPD	Max. reverse speed with speed pot at min, as % available
RAMP SHAPE	Throttle map: 20–70%
SLEEP DLY	Delay before sleep mode, in minutes
BRAKE DLY	Delay before engaging electromagnetic brake, in seconds
THRTL TYPE	Throttle type ¹
THRTL DEADBAND	Neutral deadband adjustment, as % of active range
THRTL GAIN	Restricted range throttle adjustment: 1–10
THRTL AUTOCAL	Wigwag throttle centering utility: On/Off
HIGH PEDAL DIS	High pedal disable (HPD): On/Off
FAULT BEEP	Horn beeps fault codes: On/Off
BRAKE FLTS	Electromagnetic brake driver/wiring fault check: On/Off
BEEPER SOLID	Reverse beep is continuous tone rather than pulsed: On/Off
REV BEEP	Horn sounds when vehicle traveling in reverse: On/Off

¹ Throttle types (see Throttle Wiring in Section 2)

- | | |
|---|--|
| 0: wigwag (5k Ω pots or 5V throttles) | 3: inverted single-ended pots (5k Ω –0) |
| 1: inverted wigwag (5k Ω pots or 5V throttles) | 4: single-ended voltage throttles (0–5V) |
| 2: single-ended pots (0–5k Ω) | 5: inverted single-ended voltage throttles (5V–0). |

1211 TEST MENU *(not all items available on all controllers)*

INTERNAL TEMP	Heatsink temperature, in °C
THROTTLE %	Throttle request: 0–100% of range
SPD LIMIT POT	Speed limit pot rotation: 0–100%
BATT VOLTAGE	Battery voltage across the capacitors
REVERSE INPUT	On = reverse is selected
INHIBIT IN	On = operation is inhibited
EM BRAKE DRVR	On = electromagnetic brake is mechanically released
MAIN CONT	On = voltage is applied to main relay coil
MOTOR R	Cold motor resistance, in mΩ

1211 FAULTS AND FAULT HISTORY

This is a list of the possible messages you may see displayed when the programmer is operating in either of these diagnostics modes. The messages are listed here in alphabetical order for easy reference.

BRAKE ON FAULT	Electromagnetic brake coil open or driver short
BRAKE OFF FAULT	Electromagnetic brake coil short or driver open
CURRENT SENSE FAULT	A/D current sense voltage out of range
EEPROM FAULT	Error in reading EEPROM locations
HPD	High pedal disable (HPD) fault
HW FAILSAFE	Motor voltage fault
LOW BATTERY VOLTAGE	Battery voltage too low
MAIN CONT FLTS	Main contactor did not close or did not open
MAIN ON FAULT	Main contactor driver failed short
MAIN OFF FAULT	Main contactor driver failed open
NO KNOWN FAULTS	No known faults
OVERVOLTAGE	Battery voltage too high
POWER SECTION FAULT	MOSFET driver fault, or shorted motor wiring
PRECHARGE FAULT	Capacitor bank voltage < minimum operating voltage
SPD LIMIT POT FAULT	Speed limit pot input voltage out of range
PROC/WIRING FAULT	HPD fault present >10 seconds
THERMAL CUTBACK	Cutback, due to over-/under-temperature
THROTTLE FAULT 1	Throttle input voltage out of range

7

DIAGNOSTICS AND TROUBLESHOOTING

The 1211 controller provides diagnostics information to assist technicians in troubleshooting drive system problems. On programmable models, diagnostics information can be obtained by reading the appropriate display on the handheld programmer. On models with the 9-pin logic connector, a Status LED can be used to flash the appropriate fault codes, and the horn can be programmed to sound these codes. On programmable models with the 9-pin logic connector, both diagnostic tools are available: programmer readout and fault codes flashed by the Status LED (and beeped by the horn).

PROGRAMMER DIAGNOSTICS *(PROGRAMMABLE MODELS ONLY)*

The handheld programmer presents complete diagnostic information in plain language. Faults are displayed in the Diagnostics Menu, and the status of the controller inputs/outputs is displayed in the Test Menu.

Additionally, the Fault History Menu provides a list of the faults that have occurred since the history file was last cleared. Checking (and clearing) the history file is recommended each time the vehicle is brought in for maintenance.

Refer to the troubleshooting chart (Table 3) for suggestions about possible causes of the various faults.

For information on programmer operation, see Appendix B.

LED DIAGNOSTICS *(9-PIN LOGIC CONNECTOR MODELS ONLY)*

During normal operation, with no faults present, the Status LED is steadily on. If the controller detects a fault, the Status LED provides two types of information. First, it displays a slow flash (2 Hz) or a fast flash (4 Hz) to indicate the severity of the fault. Slow-flash faults are self-clearing; as soon as the fault is corrected, the vehicle will operate normally. Fast-flash faults (“*” in Table 2) are considered to be more serious in nature and require that the keyswitch be cycled to resume operation after the fault is corrected.

After the severity indication has been active for 10 seconds, the Status LED flashes a 2-digit fault identification code continuously until the fault is corrected. For example, code “1,4”—low battery voltage—appears as:

□ □ □ □ □	□ □ □ □ □	□ □ □ □ □
(1 , 4)	(1 , 4)	(1 , 4)

The codes are listed in Table 2. Refer to the troubleshooting chart (Table 3) for suggestions about possible causes of the various faults.

Note: If the Fault Beep parameter is programmed On, the horn will sound the fault codes; see page 23.

Table 2 STATUS LED FAULT CODES

LED CODES		EXPLANATION	
<i>LED off</i>	■	no power or defective controller	
<i>solid on</i>	□	controller operational; no faults	
1,1	□ □	thermal cutback fault	
1,2	□ □□	throttle fault	
1,4	□ □□□□	undervoltage fault	
1,5	□ □□□□□	overvoltage fault	
2,1	□□ □	main contactor driver Off fault	
2,3	□□ □□□	main contactor fault	
2,4	□□ □□□□	main contactor driver On fault	
*	3,1	□□□ □	HPD fault present for >10 seconds
	3,2	□□□ □□	brake On fault
	3,3	□□□ □□□	precharge fault
	3,4	□□□ □□□□	brake Off fault
	3,5	□□□ □□□□□	HPD (High Pedal Disable) fault
*	4,1	□□□□ □	current sense fault
*	4,2	□□□□ □□	motor voltage fault (hardware failsafe)
	4,3	□□□□ □□□	EEPROM fault
*	4,4	□□□□ □□□□	power section fault

* = *Must cycle keyswitch to clear.*

NOTE: Only one fault is indicated at a time, and faults are not queued up.

Table 3 TROUBLESHOOTING CHART

LED CODE	PROGRAMMER LCD DISPLAY	EXPLANATION	POSSIBLE CAUSE
1,1	THERMAL CUTBACK	over-/under-temperature cutback	1. Temperature >92°C or < -25°C. 2. Excessive load on vehicle. 3. Operation in extreme environments. 4. Electromagnetic brake not releasing.
1,2	THROTTLE FAULT 1	throttle fault	1. Throttle input wire open or shorted. 2. Throttle pot defective. 3. Wrong throttle type selected.
1,3	SPD LIMIT POT FAULT	speed limit pot fault	1. Speed limit pot wire(s) broken or shorted. 2. Broken speed limit pot.
1,4	LOW BATTERY VOLTAGE	battery voltage too low	1. Battery voltage <16 volts. 2. Bad connection at battery or controller.
1,5	OVERVOLTAGE	battery voltage too high	1. Battery voltage >32 volts. 2. Vehicle operating with charger attached. 3. Intermittent battery connection.
2,1	MAIN OFF FAULT	main contactor driver Off fault	1. Main contactor driver failed open.
2,3	MAIN CONT FLTS	main contactor fault	1. Main contactor welded or stuck open. 2. Main contactor driver fault. 3. Brake coil resistance too high.
2,4	MAIN ON FAULT	main contactor driver On fault	1. Main contactor driver failed closed.
3,1	PROC/WIRING FAULT	HPD fault present for >10 sec.	1. Misadjusted throttle. 2. Broken throttle pot or throttle mechanism.
3,2	BRAKE ON FAULT	brake On fault	1. Electromagnetic brake driver shorted. 2. Electromagnetic brake coil open.
3,3	PRECHARGE FAULT	precharge fault	1. Low battery voltage. 2. KSI and throttle turned on at same time.
3,4	BRAKE OFF FAULT	brake Off fault	1. Electromagnetic brake driver open. 2. Electromagnetic brake coil shorted.
3,5	HPD	HPD (High Pedal Disable) fault	1. Improper sequence of throttle and KSI, or throttle and inhibit inputs. 2. Misadjusted throttle pot.
4,1	CURRENT SENSE FAULT	current sense fault	1. Short in motor or in motor wiring. 2. Controller failure. *
4,2	HW FAILSAFE	motor voltage fault (hardware failsafe)	1. Motor voltage does not correspond to throttle request. 2. Short in motor or in motor wiring. 3. Controller failure. *
4,3	EEPROM FAULT	EEPROM fault	1. EEPROM failure or fault.
4,4	POWER SECTION FAULT	power section fault	1. EEPROM failure or fault. 2. Short in motor or in motor wiring. 3. Controller failure. *

* Jack up vehicle and retest to confirm diagnosis. Clean connections, inspect system wiring, and retest.

8

MAINTENANCE

There are no user serviceable parts in the Curtis 1211 controller. **No attempt should be made to open, repair, or otherwise modify the controller.** Doing so may damage the controller and will void the warranty. However, if you have a programmable model, it is recommended that the controller's fault history file be checked and cleared periodically, as part of routine vehicle maintenance.

FAULT HISTORY *(PROGRAMMABLE MODELS ONLY)*

The programmer can be used to access the controller's fault history file. The handheld programmer will read out all the faults that the controller has experienced since the last time the history file was cleared. The faults may be intermittent faults, faults caused by loose wires, or faults caused by operator errors. Faults such as HPD or overtemperature may be caused by operator habits or by overloading.

After a problem has been diagnosed and corrected, clearing the history file is advisable. This allows the controller to accumulate a new file of faults. By checking the new history file at a later date, you can readily determine whether the problem was indeed completely fixed.

The Fault History file and Clear Fault History are in the programmer's Faults Menu; see Appendix B.

APPENDIX A

VEHICLE DESIGN CONSIDERATIONS REGARDING ELECTROMAGNETIC COMPATIBILITY (EMC) AND ELECTROSTATIC DISCHARGE (ESD)

ELECTROMAGNETIC COMPATIBILITY (EMC)

Electromagnetic compatibility (EMC) encompasses two areas: emissions and immunity. *Emissions* are radio frequency (RF) energy generated by a product. This energy has the potential to interfere with communications systems such as radio, television, cellular phones, dispatching, aircraft, etc. *Immunity* is the ability of a product to operate normally in the presence of RF energy.

EMC is ultimately a system design issue. Part of the EMC performance is designed into or inherent in each component; another part is designed into or inherent in end product characteristics such as shielding, wiring, and layout; and, finally, a portion is a function of the interactions between all these parts. The design techniques presented below can enhance EMC performance in products that use Curtis motor controllers.

Decreasing Emissions

Motor brush arcing can be a significant source of RF emissions. These emissions may be reduced by installing bypass capacitors across the motor wires and/or between each motor wire and the motor frame. If the latter approach is used, the voltage rating and leakage characteristics of the capacitors must be adequate to meet any safety regulations regarding electrical connections between a battery operated circuit and the chassis. The bypass capacitor should be installed as close to the motor as possible, or even inside it, to provide the best performance. Alternatively a ferrite bead can be installed on the wires, as close as possible to the motor. In some instances, capacitors and ferrite beads may both be appropriate. Another option is to choose a motor with a brush material that will result in less arcing to the commutator. Brushes that have been run in for approximately 100 hours will typically generate lower emissions than new brushes because there is less arcing after they are properly seated.

The motor drive output from Curtis controllers can also make a contribution to RF emissions. This output is a pulse width modulated square wave with rather fast rise and fall times that are rich in harmonics. The impact of these switching waveforms can be minimized by making the wires from the controller to the motor as short as possible. Ferrite beads installed on the drive wires can further reduce these emissions. For applications requiring very low emissions, the solution may involve enclosing the controller, interconnect wires, and motor together in one shielded box. The motor drive harmonics can couple to battery supply leads and throttle circuit wires, so ferrite beads may also be required on these other wires in some applications.

Increasing Immunity

Immunity to radiated electric fields can be achieved either by reducing the overall circuit sensitivity or by keeping the undesired signals away from this circuitry. The controller circuitry itself cannot be made less sensitive, since it must accurately detect and process low level signals from the throttle potentiometer. Thus immunity is generally achieved by preventing the external RF energy from coupling into sensitive circuitry. This RF energy can get into the controller circuitry via conducted paths and via radiated paths.

Conducted paths are created by the wires connected to the controller. These wires act as antennas and the amount of RF energy coupled into these wires is generally proportional to their length. The RF voltages and currents induced in each wire are applied to the controller pin to which the wire is connected. Curtis motor controllers include bypass capacitors on the printed circuit board's throttle wires to reduce the impact of this RF energy on the internal circuitry. In some applications, ferrite beads may also be required on the various wires to achieve desired performance levels.

Radiated paths are created when the controller circuitry is immersed in an external field. This coupling can be reduced by enclosing the controller in a metal box. Some Curtis motor controllers are enclosed by a heat sink that also provides shielding around the controller circuitry, while others are unshielded. In some applications, the vehicle designer will need to mount the controller within a shielded box on the end product. The box may be constructed of just about any metal, although steel and aluminum are most commonly used.

Most coated plastics do not provide good shielding because the coatings are not true metals, but rather a mixture of small metal particles in a non-conductive binder. These relatively isolated particles may appear to be good based on a dc resistance measurement but do not provide adequate electron mobility to yield good shielding effectiveness. Electroless plating of plastic will yield a true metal and can thus be effective as an RF shield, but it is usually more expensive than the coatings.

A contiguous metal enclosure without any holes or seams, known as a Faraday cage, provides the best shielding for the given material and frequency. When a hole or holes are added, RF currents flowing on the outside surface of the shield must take a longer path to get around the hole than if the surface was contiguous. As more "bending" is required of these currents, more energy is coupled to the inside surface, and thus the shielding effectiveness is reduced. The reduction in shielding is a function of the longest linear dimension of a hole rather than the area. This concept is often applied where ventilation is necessary, in which case many small holes are preferable to a few larger ones.

Applying this same concept to seams or joints between adjacent pieces or segments of a shielded enclosure, it is important to minimize the open length of these seams. Seam length is the distance between points where good ohmic contact is made. This contact can be provided by solder, welds, or pressure contact. If pressure contact is used, attention must be paid to the corrosion characteristics of the shield material and any corrosion-resistant processes applied

to the base material. If the ohmic contact itself is not continuous, the shielding effectiveness can be maximized by making the joints between adjacent pieces overlapping rather than abutted.

The shielding effectiveness of an enclosure is further reduced when a wire passes through a hole in the enclosure. RF energy on the wire from an external field is re-radiated into the interior of the enclosure. This coupling mechanism can be reduced by filtering the wire at the point where it passes through the boundary of the shield. Given the safety considerations involved with connecting electrical components to the chassis or frame in battery powered vehicles, such filtering will usually consist of a series inductor (or ferrite bead) rather than a shunt capacitor. If a capacitor is used, it must have a voltage rating and leakage characteristics that will allow the end product to meet applicable safety regulations.

The B+ (and B-, if applicable) wires that supply power to the throttle control panel—such as for the keyswitch—should be bundled with the remaining throttle wires so that all these wires are routed together. If the wires to the control panel are routed separately, a larger loop area is formed. Larger loop areas produce more efficient antennas which will result in decreased immunity performance.

ELECTROSTATIC DISCHARGE (ESD)

Curtis motor controllers contain ESD-sensitive components, and it is therefore necessary to protect them from ESD damage. Electrostatic discharge (ESD) immunity is achieved either by providing sufficient distance between conductors and the outside world so that a discharge will not occur, or by providing an intentional path for the discharge current such that the circuit is isolated from the electric and magnetic fields produced by the discharge. In general the guidelines presented above for increasing the radiated immunity will also provide increased ESD immunity.

It is usually easier to prevent the discharge from occurring than to divert the current path. A fundamental technique for ESD prevention is to provide adequately thick insulation between all metal conductors and the outside environment so that the voltage gradient does not exceed the threshold required for a discharge to occur. However, in some scooter applications isolation may not be appropriate; in these cases, connection to chassis ground may be required. If the current diversion approach is used, all exposed metal components must be grounded. The shielded enclosure, if properly grounded, can be used to divert the discharge current; it should be noted that the location of holes and seams can have a significant impact on the ESD suppression. If the enclosure is not grounded, the path of the discharge current becomes more complex and less predictable, especially if holes and seams are involved. Some experimentation may be required to optimize the selection and placement of holes, wires, and grounding paths. Careful attention must be paid to the control panel design so that it can tolerate a static discharge.

APPENDIX B

PROGRAMMER OPERATION

Curtis programmers provide programming, diagnostic, and test capabilities for the 1211 controller. The power for operating the programmer is supplied by the host controller via a 4-pin connector. Two programmers are available: the PC Programming Station (1314) and the handheld programmer (1311). The Programming Station has features not available on the handheld unit; on the other hand, the handheld programmer has the advantage of being more portable. Typically the Programming Station is used to set up the parameters initially and the handheld programmer is used to make adjustments in the field.

Two versions of each programmer are available: the User programmers can adjust only User-access parameters, whereas the OEM programmers can adjust all the parameters.

HANDHELD PROGRAMMER (1311)

The 1311 programmer is easy to use, with self-explanatory functions. After plugging in the programmer, wait a few seconds for it to boot up and gather

Fig. B-1 Curtis 1311 handheld programmer.

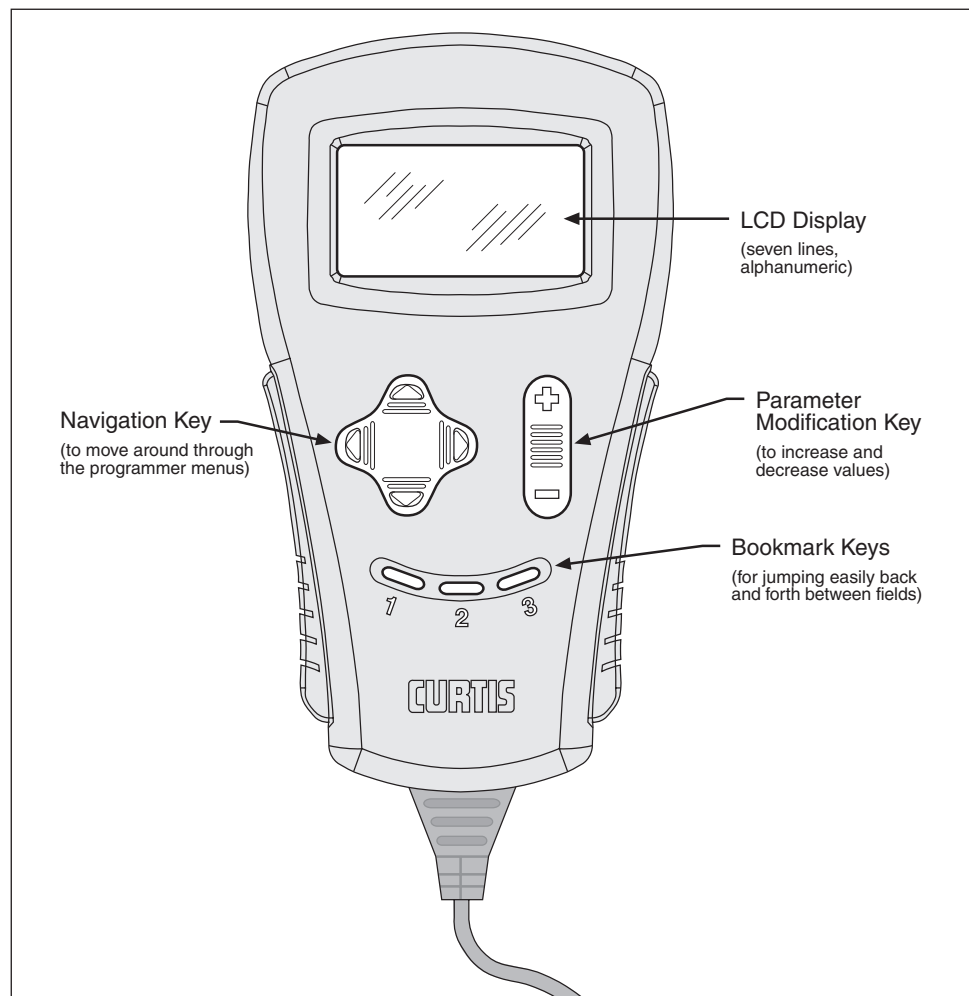

information from the controller. For experimenting with settings, the programmer can be left plugged in while the vehicle is driven.

The bookmark keys can make parameter adjustment more convenient. To set a bookmark, press one of the three bookmark keys for more than two seconds. To jump to a bookmarked location, press the appropriate bookmark key quickly (for less than two seconds).

The bookmark keys also have another function that makes programming easier. When setting the value of a parameter, you can use these keys to adjust the increments by which the value changes—with Bookmark Key 1, the value changes in 10-digit steps up or down; with Bookmark Key 2 pressed, the value changes in 100-digit steps; and with Bookmark Key 3, in 1000-digit steps—which, for most parameters, takes you from the maximum to the minimum, or vice versa.

PC PROGRAMMING STATION (1314)

The Programming Station is an MS-Windows 32-bit application that runs on a standard Windows PC. It can do everything the handheld programmer can do, and more. Its additional capabilities include saving/restoring sets of parameters to/from disk and updating software. Instructions for using the Programming Station are included with the software.

PROGRAMMER MENUS

The programmers have six menus:

Program — provides access to the individual programmable parameters.

Monitor — presents real-time values during vehicle operation; these include all inputs and outputs.

Faults — presents diagnostic information, and also a means to clear the fault history file.

Functions — provides access to the controller-cloning commands and to the “reset” command.

Information — displays data about the host controller: model and serial numbers, date of manufacture, hardware and software revisions, and itemization of other devices that may be associated with the controller’s operation.

Programmer Setup — displays data about the programmer: model and serial numbers, and date of manufacture.

APPENDIX C

SPECIFICATIONS

Table C-1 SPECIFICATIONS: 1211 CONTROLLER

Nominal input voltage	24 V
Current rating	30 A or 45 A
PWM operating frequency	15 kHz
Electrical isolation to heatsink	500 V (minimum)
Minimum motor resistance	160 m Ω
B+, B- logic pin current (max.)	9 A (J2 connector, pins 1 and 6)
KSI input current (typical)	50 mA without programmer; 150 mA with programmer
KSI input current (peak)	1.5 A
Logic input current (typical)	1 mA
Horn output current (max.)	15 mA
Electromagnetic brake coil resistance	32–200 Ω
Control input switch type	on/off
Speed control signal	3-wire, 5k Ω ; or 0–5V
Speed control type	wigwag or inverted wigwag (<i>available on all models</i>) single-ended or inverted single-ended (<i>available only on 9-pin models</i>)
Operating ambient temperature range	-25°C to 60°C (-13°F to 140°F)
Storage ambient temperature range	-40°C to 75°C (-40°F to 167°F)
Internal overtemperature cutback	linear cutback starts at 80°C (176°F)
Internal undertemperature cutback	50% armature current at -25°C (-13°F)
Voltage drop at 20 A	0.45 V
Undervoltage cutback	16 V
Overvoltage cutoff	32 V
Package environmental rating	IP64 (IEC 529)
Weight	0.32 kg (0.7 lb)
Dimensions (L×W×H)	73 × 99 × 39 mm (2.87" × 3.90" × 1.54")
Regulatory compliance	Designed to ANSI RESNA WC 14/21, ISO 7176-14, ISO 7176-21, and EN 12184. Documentation available to support 510K FDA filings. Please contact Curtis Instruments for further regulatory approvals and assistance.

MODEL NUMBER	TYPE	LOGIC CONNECTOR	ADDITIONAL FEATURES ON 9-PIN MODELS	PROGRAMMER CABLE	NOMINAL BATTERY VOLTAGE	CURRENT RATING
1211-2201	generic	6-pin	—	yes	24 V	30 A
1211-2202	generic	9-pin	Reverse, Horn, Status	yes	24 V	30 A
1211-22XX	custom	6-pin or 9-pin	custom	optional	24 V	30 A
1211-2401	generic	6-pin	—	yes	24 V	45 A
1211-2402	generic	9-pin	Reverse, Horn, Status	yes	24 V	45 A
1211-2403	generic	9-pin	Speed Pot, Horn, Status	yes	24 V	45 A
1211-24XX	custom	6-pin or 9-pin	custom	optional	24 V	45 A