

---

# MANUAL

---

---

MODEL **1266**

**MOTOR CONTROLLER**

---

© 2006 CURTIS INSTRUMENTS, INC.

DESIGN OF CURTIS 1200 SERIES  
CONTROLLERS PROTECTED BY U.S.  
PATENT NO. 4626750.

1266 Manual, p/n 38228  
Rev. A: October 2006



**CURTIS INSTRUMENTS, INC.**

200 Kisco Avenue  
Mt. Kisco, New York 10549 USA  
Tel. 914.666.2971  
Fax 914.666.2188

[www.curtisinstruments.com](http://www.curtisinstruments.com)



# CONTENTS

1. OVERVIEW .....	1
2. INSTALLATION AND WIRING.....	4
Mounting the Controller .....	4
Connections: Low Current.....	6
Connections: High Current .....	7
Wiring: Controller .....	8
Wiring: Throttle.....	10
Wiring: Drivers .....	12
Wiring: Pedal Interlock Switch.....	13
Contactor, Switches, and Other Hardware.....	14
3. PROGRAMMABLE PARAMETERS .....	15
Acceleration/Deceleration Parameters.....	17
Acceleration Rate: M1, M2, Reverse	
Deceleration Rate: M1, M2, Reverse	
Field Brake	
Field Brake Speed	
Field Brake Max	
Field Brake Rate	
Speed Parameters .....	19
Max Forward Speed: M1, M2	
Max Reverse Speed	
RPM To Speed	
Tacho Poles	
Throttle Parameters.....	20
Throttle 0%	
Throttle 100%	
Throttle Map	
Throttle Fault Low	
Throttle Fault High	
Current Limit Parameters.....	21
Main Current Limit: M1, M2	
Regen Current Limit	
Plug Braking Current Limit	
WalkAway™ Current Limit	
Brake Mapping Parameters .....	22
Brake Minimum: M1, M2, Reverse	
Brake Maximum: M1, M2, Reverse	
Brake Start: M1, M2, Reverse	
Brake End: M1, M2, Reverse	
Brake Map: M1, M2, Reverse	
Field Mapping Parameters.....	25
Forward Field Minimum: M1, M2	
Reverse Field Minimum	
Field Max	
Negative Field Maximum	

	Field Map Start / Negative Field Map Start	
	Field Map End / Negative Field Map End	
	Field Ramp / Negative Field Ramp	
	Fault Parameters.....	26
	KSI SRO Enable	
	Mode After KSI	
	Overvoltage	
	Low Voltage	
	Warning Option	
	Output Driver Parameters.....	28
	Auxiliary Driver Mode	
	Auxiliary Pull-In Voltage	
	Auxiliary Holding Voltage	
	Electromagnetic Brake Delay	
	Electromagnetic Brake Speed Check	
	Electromagnetic Brake at Speed Value	
4.	INSTALLATION CHECKOUT .....	30
5.	TUNING GUIDE .....	32
	Major Tuning.....	32
	① Tuning the active throttle range.....	32
	② Calibrating the controller speed measurement.....	34
	③ Tuning the controller to the motor .....	34
	④ Equalizing loaded and unloaded vehicle speed .....	37
	⑤ Confirming loaded vehicle speed on downhill.....	38
	Fine Tuning.....	39
	⑥ Response to increased throttle .....	39
	⑦ Response to full throttle release .....	40
	⑧ Transitioning from flat ground to downhill .....	42
	⑨ Hill climbing.....	42
	⑩ WalkAway™ braking.....	43
	⑪ Low-speed field braking .....	43
	⑫ EM brake operation .....	44
6.	DIAGNOSTICS AND TROUBLESHOOTING.....	46
7.	MAINTENANCE .....	49
	<b>APPENDIX A</b> Vehicle Design Considerations	
	<b>APPENDIX B</b> 1311 Programmer Operation	
	<b>APPENDIX C</b> Programmable Parameter Index	
	<b>APPENDIX D</b> Specifications, 1266 Controller	

---

**FIGURES**

FIG. 1:	Curtis 1266 electronic motor controller.....	1
FIG. 2:	Mounting dimensions, Curtis 1266 controller .....	4
FIG. 3a:	Standard wiring configuration — with aux driver used for an EM brake.....	8
FIG. 3b:	Standard wiring configuration — with aux driver used for a WalkAway™ relay .....	9
FIG. 4:	Wiring for 3-wire potentiometer throttle .....	10
FIG. 5:	Wiring for 0–5V throttle .....	10
FIG. 6:	Wiring for ITS throttle .....	11
FIG. 7:	Throttle map structure .....	20
FIG. 8:	Brake map structure .....	23
FIG. 9:	Field map structure .....	25
FIG. B-1:	Curtis 1311 handheld programmer .....	B-1



# 1

## OVERVIEW

Curtis 1266 controllers are separately excited motor speed controllers designed for use in a variety of transport vehicles. These programmable controllers are simple to install, efficient, and cost effective. Typical applications include golf carts and small utility vehicles.

The 1266 controller offers smooth, silent, cost effective control of motor speed and torque. The speed sensor input allows superior closed-loop control for regulating vehicle speed. Unique braking parameters allow simple, intuitive deceleration tuning. A full-bridge field winding control stage is combined with a half-bridge armature power stage to provide solid state motor reversing and regenerative braking power without additional relays or contactors.

**Fig. 1** *Curtis 1266 electronic motor controller.*



These controllers are fully programmable by means of the optional 1311 handheld programmer or 1314 PC programming station. Use of a programmer provides diagnostic and test capability as well as configuration flexibility and the ability to easily transfer settings from one controller to another.

Like all Curtis motor controllers, the 1266 offers superior operator control of the vehicle's motor drive speed. **Features include:**

- ✓ Regenerative braking, providing longer operation on a single battery charge and reducing motor brush wear and motor heating
- ✓ Adjustable brake rates, for smooth pedal-release braking
- ✓ Two user-selectable vehicle operating personalities, with vehicle top speed controlled and limited in each mode
- ✓ Motor parameters are programmable to match the characteristics of the specific motor being used
- ✓ Vehicle speed control is enhanced through feedback from a Hall effect speed sensor
- ✓ Anti-rollback function, providing improved control when throttle is released on hills
- ✓ Anti-stall function helps prevent motor commutator damage
- ✓ High pedal disable (HPD) and static return to off (SRO) interlocks prevent vehicle runaway at startup
- ✓ WalkAway™ braking feature limits any stopped or key-off rolling to a very low speed
- ✓ Auxiliary driver can be programmed for either an electromagnetic (EM) brake or a WalkAway™ relay
- ✓ Coil driver provides adjustable pull-in and holding voltages to WalkAway™ relay or EM brake
- ✓ Reverse signal driver provides a low signal any time the vehicle is traveling in reverse

- ✓ Driver outputs are short circuit protected and provide built-in coil spike protection
- ✓ Warning buzzer sounds steady in reverse, intermittent during WalkAway™ braking
- ✓ Complete diagnostics through any of the optional programmers and through the built-in Status LED
- ✓ Splash resistant plastic cover
- ✓ Meets or exceeds EEC fault detect requirements.

Familiarity with your Curtis controller will help you install and operate it properly. We encourage you to read this manual carefully. If you have questions, please contact the Curtis office nearest you.

## 2

## INSTALLATION AND WIRING

## MOUNTING THE CONTROLLER

The outline and mounting hole dimensions for the 1266 controller are shown in Figure 2.

The controller can be oriented in any position; however, **the location should be carefully chosen to keep the controller as clean and dry as possible. If a clean, dry mounting location cannot be found, a cover must be used to shield the controller from water and contaminants.** When selecting the mounting position, be sure to also take into consideration (1) that access is needed at the side of the controller to plug the programmer into its connector, and (2) that the built-in Status LED is visible only through the view port in the label on top of the controller.

**Fig. 2** Mounting dimensions, Curtis 1266 controller.

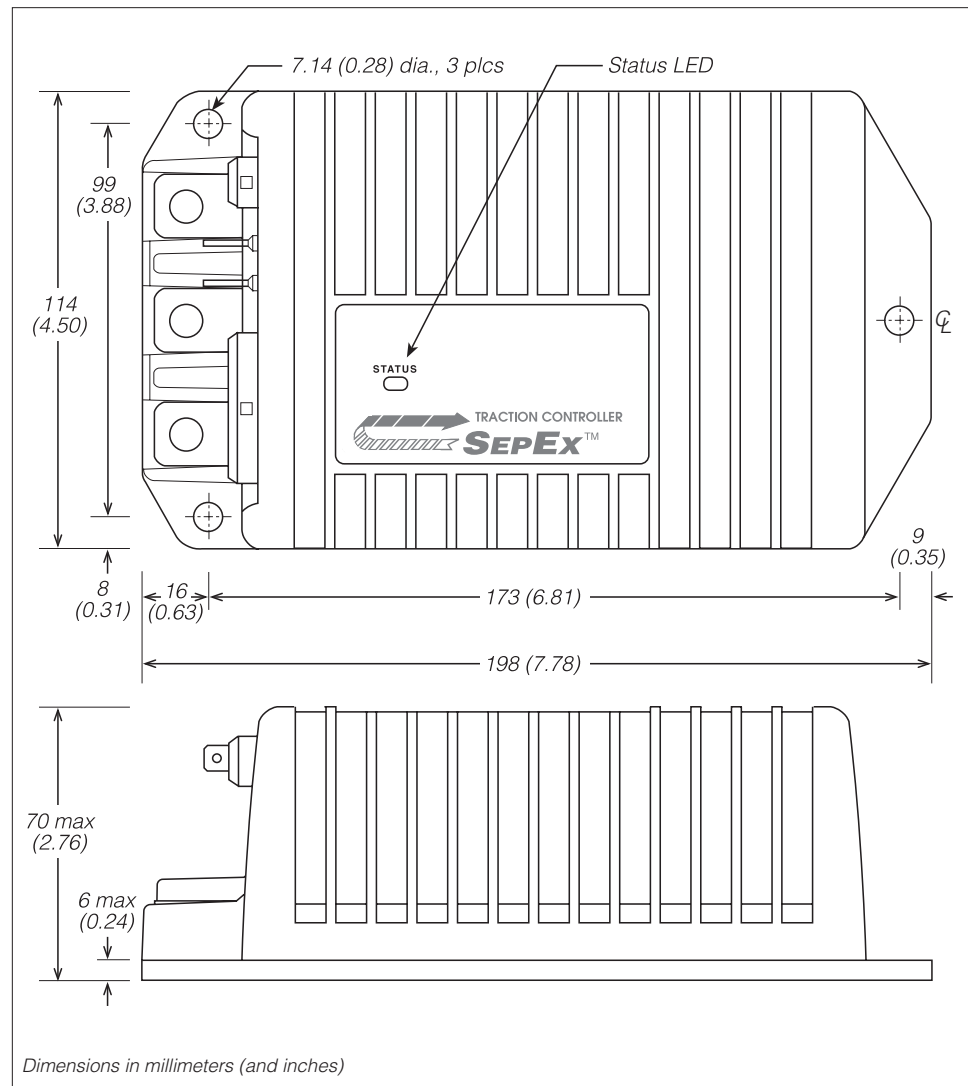

To ensure full rated power, the controller should be fastened to a clean, flat metal surface with three 6mm (1/4") diameter screws, using the holes provided. Although not required, a thermal joint compound can be used to improve heat conduction from the controller heatsink to the mounting surface.

You will need to take steps during the design and development of your end product to ensure that its EMC performance complies with applicable regulations; suggestions are presented in Appendix A.

The 1266 controller contains ESD-sensitive components. Use appropriate precautions in connecting, disconnecting, and handling the controller. See installation suggestions in Appendix A for protecting the controller from ESD damage.



**Working on electric vehicles is potentially dangerous.** You should protect yourself against runaways, high current arcs, and outgassing from lead acid batteries:

**RUNAWAYS** — Some conditions could cause the vehicle to run out of control. Disconnect the motor or jack up the vehicle and get the drive wheels off the ground before attempting any work on the motor control circuitry.

**HIGH CURRENT ARCS** — Electric vehicle batteries can supply very high power, and arcs can occur if they are short circuited. Always open the battery circuit before working on the motor control circuit. Wear safety glasses, and use properly insulated tools to prevent shorts.

**LEAD ACID BATTERIES** — Charging or discharging generates hydrogen gas, which can build up in and around the batteries. Follow the battery manufacturer's safety recommendations. Wear safety glasses.

## CONNECTIONS

### Low Current Connections

Two low current connectors are built into the 1266 controller: a 16-pin connector and a 4-pin connector. They are located on the side of the controller.

The **16-pin** connector provides the logic control connections. The mating connector is a 16-pin Molex Mini-Fit Jr. connector p/n 39-01-2165 using type 5556 terminals. The appropriate wire gauge is 18–24 AWG.

Note: The +15V supply (Pin 10) should only be used with the speed sensor and not to power any other external systems.

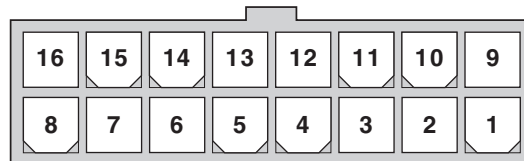

<b>Pin 1</b>	Hall Signal	<i>input signal from motor speed sensor</i>
<b>Pin 2</b>	Auxiliary Driver	<i>WalkAway™/EMB driver low-side output</i>
<b>Pin 3</b>	Reverse Alarm	<i>alarm low-side driver output</i>
<b>Pin 4</b>	Pot High	<i>+5V supply through 453Ω (or ITS input)</i>
<b>Pin 5</b>	Pot Wiper	<i>throttle wiper input</i>
<b>Pin 6</b>	Pot Low	<i>453Ω to ground</i>
<b>Pin 7</b>	Main Contactor	<i>contactor coil driver low-side output</i>
<b>Pin 8</b>	Logic Enable	<i>input from run/store switch</i>
<b>Pin 9</b>	Hall -	<i>B- ground for motor speed sensor</i>
<b>Pin 10</b>	Hall +	<i>+15V supply for motor speed sensor</i>
<b>Pin 11</b>	Reverse	<i>input from reverse switch</i>
<b>Pin 12</b>	Forward	<i>input from forward switch</i>
<b>Pin 13</b>	Pedal Interlock Switch	<i>input from pedal switch, wired to throttle</i>
<b>Pin 14</b>	Mode Switch	<i>input from mode switch</i>
<b>Pin 15</b>	Keyswitch Input (KSI)	<i>throttle wiper input (or ITS input)</i>
<b>Pin 16</b>	Logic Power	<i>power to controller logic</i>

1	Rx Data
2	B-
3	Tx Data
4	+15V

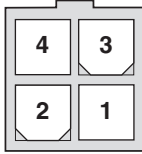

A **4-pin** low power connector is provided for an optional programmer. A complete handheld programmer kit, including the appropriate connecting cable with mating connector, can be ordered from Curtis:

*p/n 168961101 for the User Programmer (model 1311-1101)*

*p/n 168962101 for the OEM Programmer (model 1311-4401).*

If a handheld programmer is already available (such as the now discontinued 1307) but has an incompatible cable, the appropriate connecting cable can be ordered as a separate part: *p/n 16185*.

If a 1314 PC programming station is used, the 1309 interface box and cable connect the computer to the controller:

*p/n 117465704 1314-1101, 1314 PC Programming Station (User) CD-ROM*

*p/n 117465707 1314-4401, 1314 PC Programming Station (OEM) CD-ROM*

*p/n 16994001 1309 Interface Box*

*p/n 16185 Molex cable for 1309 Interface Box.*

#### High Current Connections

Three tin-plated solid copper bus bars are provided for the high current connections to the battery (**B+** and **B-**) and the motor armature (**M-**). Cables are fastened to the bus bars by M8 bolts. The 1266 case provides the capture nuts required for the M8 bolts. The maximum bolt insertion depth below the surface of the bus bar is 13 mm (1/2"). Bolt shafts exceeding this length may damage the controller. The torque applied to the bolts should not exceed 16.3 N·m (12 ft-lbs).

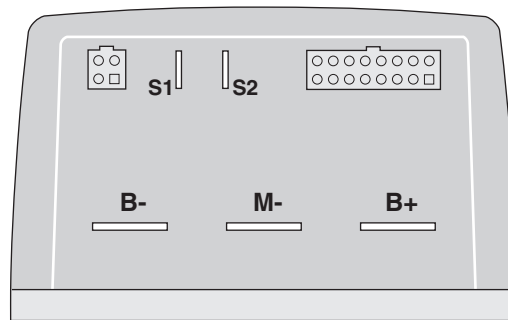

Two 1/4" quick connect terminals (**S1** and **S1**) are provided for the connections to the motor field winding.

### WIRING: Standard Configuration

Figures 3a and 3b show typical wiring. The system can include an electromagnetic brake or a WalkAway™ relay, but not both. Figure 3a shows a system with an EM brake; Figure 3b shows a system with a WalkAway™ relay.

#### Standard Power Wiring

Motor armature winding is straightforward, with the armature's **A1** connection going to the controller's B+ bus bar and the armature's **A2** connection going to the controller's M- bus bar.

The motor's field connections (**F1** and **F2**) to the controller are less obvious. The direction of vehicle travel with the forward direction selected will depend on how the **F1** and **F2** connections are made to the controller's two field terminals and how the motor shaft is connected to the drive wheels through the vehicle's drive train.

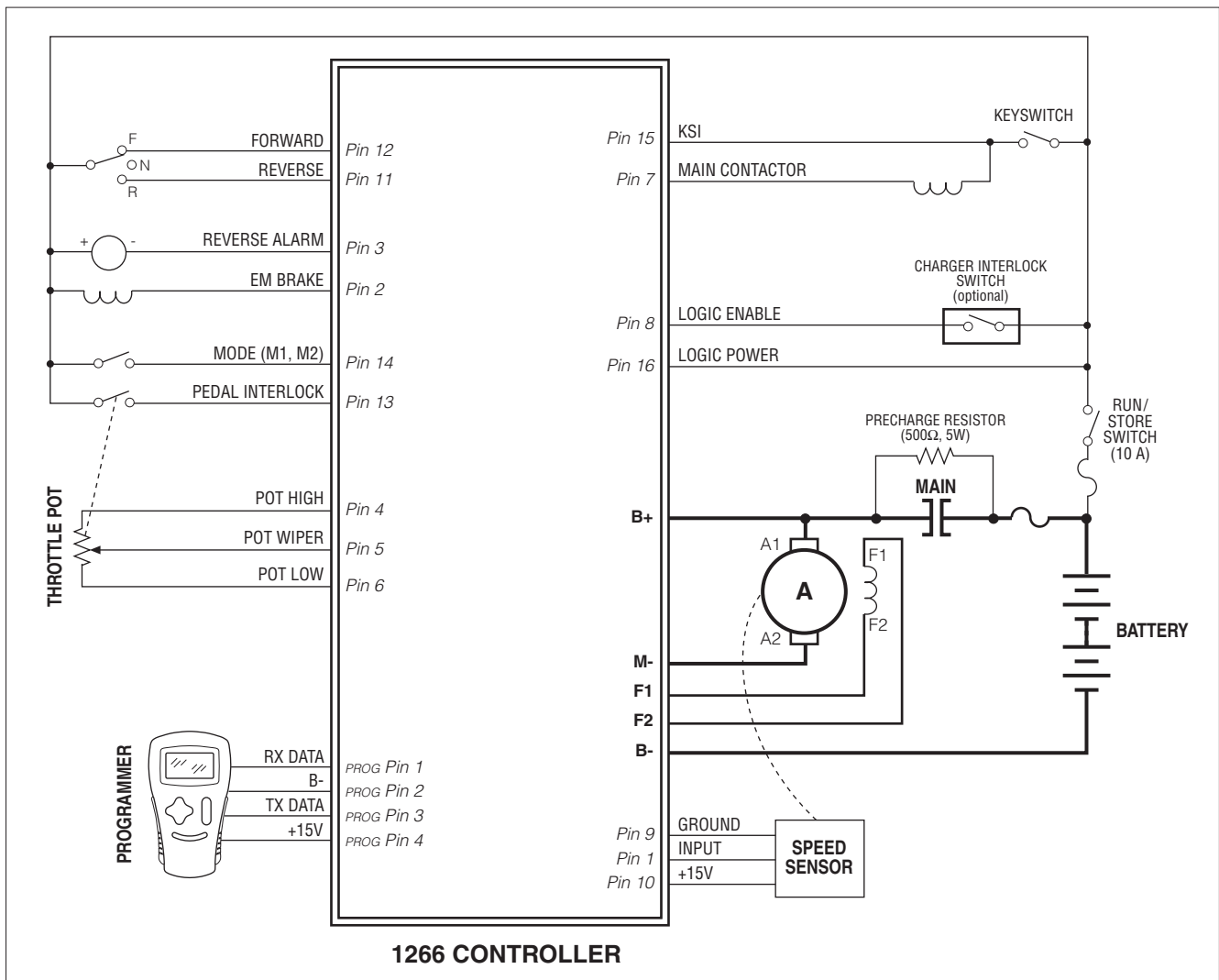
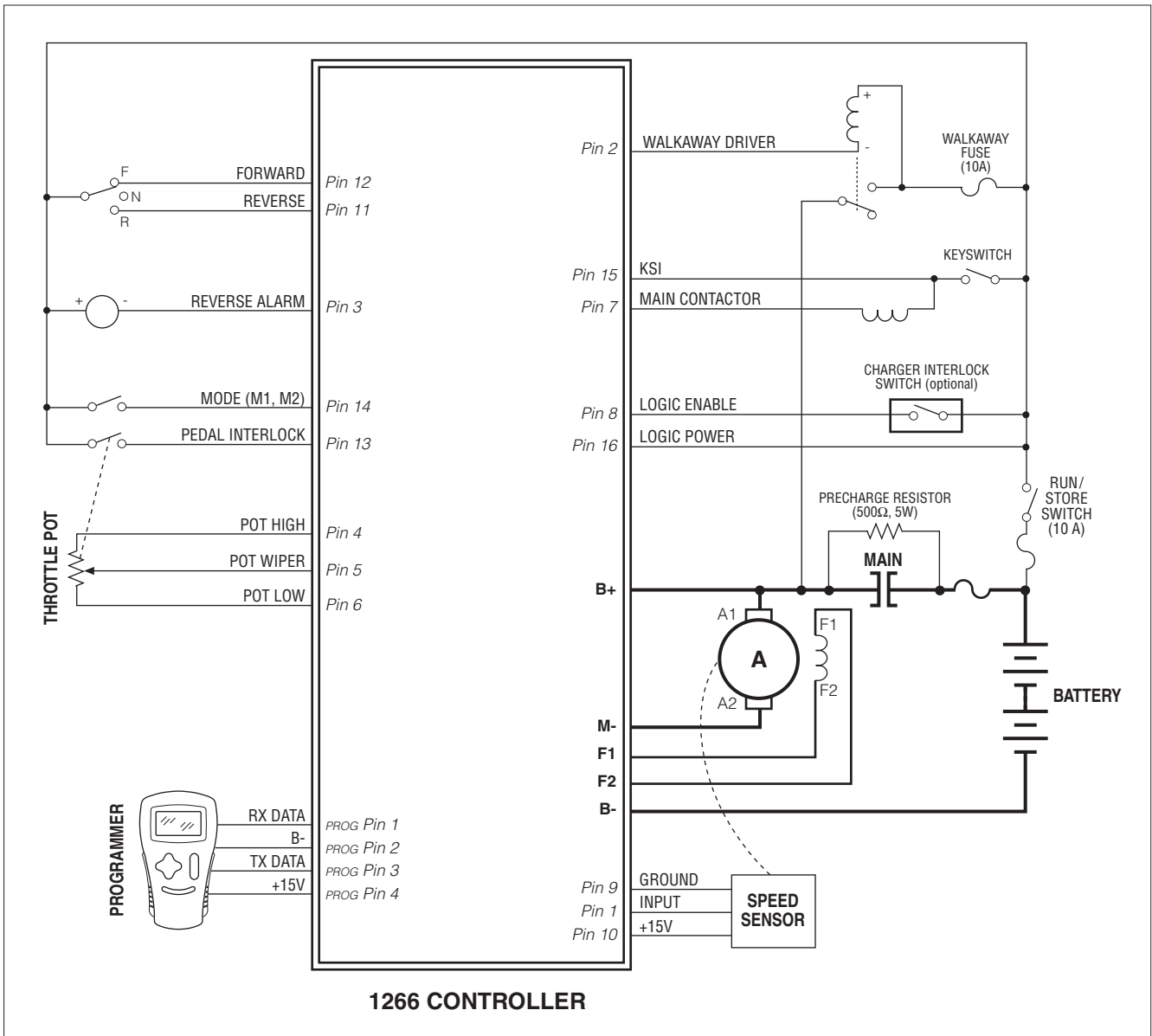

**Fig. 3a** Standard wiring configuration for Curtis 1266 controller, in an application with an EM brake.

*Standard Control Wiring*

Wiring is shown in Figures 3a and 3b for the most commonly used components. Wiring for alternative throttles is shown in the following pages.

The main contactor coil must be wired directly to the controller as shown in Figures 3a and 3b. The controller uses the main contactor coil driver output to remove power from the controller and motor in the event of various faults. **If the main contactor coil is not wired to Pin 7, the controller will not be able to open the main contactor in serious fault conditions and the system will therefore not meet EEC safety requirements.**



**Fig. 3b** Standard wiring configuration for Curtis 1266 controller, in an application with the WalkAway™ function.

## WIRING: Throttle

Various throttles can be used with the 1266 controller, including  $5\text{k}\Omega$  3-wire potentiometers and 0–5V throttles. Some 1266 controller models are specifically designed to be compatible with ITS throttles.

The controller looks for a voltage signal at the wiper input (Pin 15), with vehicle speed increasing with increased throttle voltage. All throttle fault protection is accomplished by monitoring the wiper input. This provides throttle fault protection that meets all EEC requirements. Thus, no additional fault protection is required on any throttle type used with the 1266 controller.

If the throttle you are planning to use is not covered, contact the Curtis office nearest you.

### 3-Wire Potentiometer ( $5\text{k}\Omega$ – $10\text{k}\Omega$ ) Throttle

The 3-wire potentiometer is used in its voltage divider mode, with the voltage source and return being provided by the controller. Pot High (Pin 4) provides a current limited 5V source to the pot, and Pot Low (Pin 6) provides the return path. The pot wiper is then connected to the Wiper Input (Pin 5). Potentiometers with total resistance values between  $5\text{k}\Omega$  and  $10\text{k}\Omega$  can be used. Wiring is shown in Figure 4.

**Fig. 4** Wiring for 3-wire potentiometer throttle.

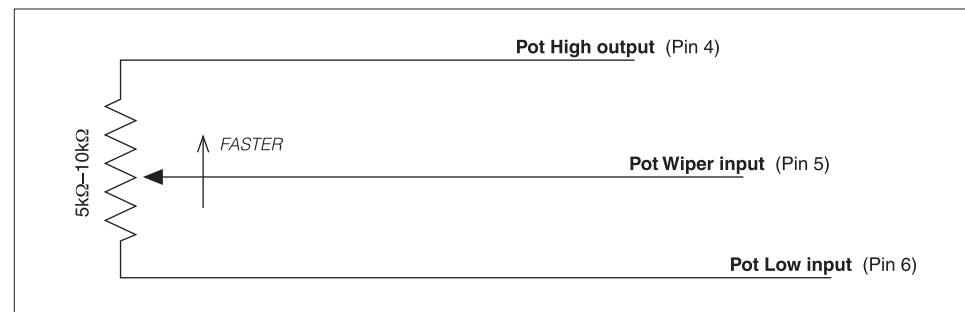

This wiring is also shown in the standard wiring diagrams, Figs. 3a and 3b.

### 0–5V Throttle

The active range for the 0–5V throttle is set by the parameters Throttle 0% and Throttle 100%, and is measured relative to B-. Wiring is shown in Figure 5.

**Fig. 5** Wiring for 0–5V throttle.

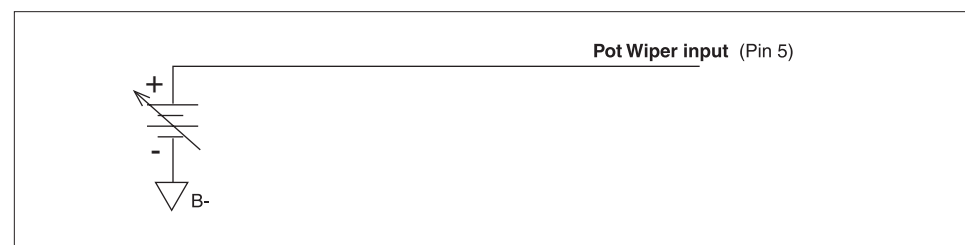

### ITS Throttle

The ITS throttle is a 2-wire electronic throttle that connects between the Pot High and Pot Wiper pins (Pins 4 and 5), as shown in Figure 6. The Hall sensor circuit within the throttle creates an output current between 0.7mA and 1.6mA from min to max throttle. The two wires are interchangeable.

**Fig. 6** *Wiring for ITS throttle.*

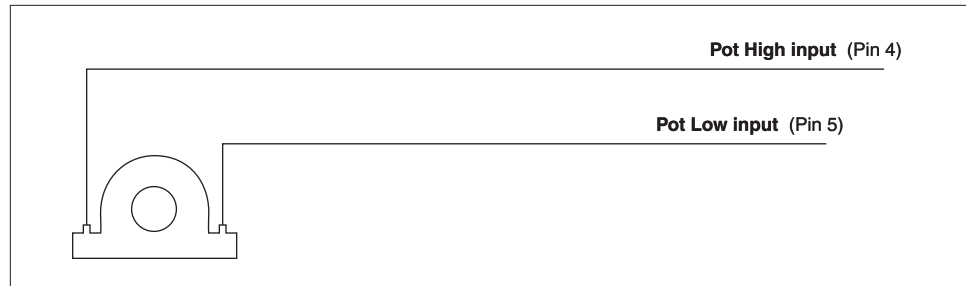

Note: ITS throttles can only be used with 1266 models that are specifically designed for them.

## WIRING: Drivers

The 1266 controller provides three drivers (at Pins 2, 3, 7) for the aux contactor/relay, reverse alarm, and main contactor. These three outputs are low-side drivers, designed to energize inductive coils or a piezoelectric reverse alarm. The reverse alarm and aux are optional functions.

With the exception of the coil used at the aux driver (Pin 2), it is necessary to specify the connected coil voltage at the nominal battery pack voltage. The aux driver can be set to either 100%, 60%, or 35% of system voltage. These fixed percentages are used for the Coil Pull-In Voltage and Holding Voltage. See Section 3 for more information on programming these parameters.

A coil suppression diode is provided internally to protect two of the drivers (2, 7) from inductive spikes generated at turn-off. To take advantage of the controller's internal coil suppression diode, the coils must be wired such that the return path to the drivers cannot be opened by any switches or contactors, as shown in the standard wiring diagrams (pages 8, 9).

DRIVER	PIN	RATED CURRENT	RATED LOAD VOLTAGE	INTERNAL DIODE PROTECTION
Main Contactor	7	2.0 A	B+	yes
Reverse Alarm	3	0.02 A	B+	no
Aux (EMB/WalkAway™)	2	2.0 A	B+, 36V, 24V	yes

The driver loads are not limited to contactor coils. Any load can be connected to a Pin 3 or 7 driver as long as it does not exceed the current rating.

For information on programming the various driver-related parameters, see Section 3: Programmable Parameters.

### *Main Contactor Driver*

The main contactor driver (Pin 7) pulls low when (a) the tow/store switch, keyswitch input, and pedal interlock switch are enabled, (b) a direction is selected, and (c) throttle is applied; it stays low until near zero speed at zero throttle, or until a critical fault occurs. This wiring is shown in the standard wiring diagrams (pages 8, 9).

### *Reverse Alarm Driver*

The reverse alarm driver (Pin 3) pulls low when the reverse direction switch is applied. This driver is designed to drive a reverse signal beeper or piezoelectric buzzer that operates when the vehicle is traveling in reverse or during WalkAway™ operation. It can also be programmed to give a warning during anti-rollback and/or to warn of an overvoltage condition (see Warning Option parameter).

### *Auxiliary Driver*

The condition for which the auxiliary driver (Pin 2) pulls low depends on how it is being used. With an EM brake, the driver becomes active (low) when the vehicle is commanded into motion so as to activate the brake coil and pull in the brake. In a WalkAway™ system, the driver becomes active when the vehicle is rolling while the main contactor is not engaged.

The aux driver's output is pulse width modulated at the coil holding voltage set by the Holding Voltage parameter. The pull-in voltage set by the Pull-In Voltage parameter is used in place of the holding voltage for the first 100 milliseconds.

When the aux driver is used with an EM brake, the EMB Delay parameter allows for the adjustment of a time delay before the brake engages after the vehicle is stopped or has slowed below the threshold set by the EMB Speed Value parameter.

### **WIRING: Pedal Interlock Switch**

Controller output is possible only when the pedal interlock input (Pin 13) is pulled to B+. The pedal interlock switch is connected to the throttle mechanism, thus guaranteeing zero controller output when the operator releases the throttle. This adds a safety feature to protect against throttle failures that could otherwise cause unintended controller output (vehicle motion).

## CONTACTOR, SWITCHES, and OTHER HARDWARE

### *Main Contactor*

A main contactor is required for use with any 1266 controller. The main contactor allows the controller and motor to be disconnected from the battery. This provides a significant safety feature in that the battery power can be removed from the drive system if a controller or wiring fault is detected. A single-pole, single-throw (SPST) contactor with silver-alloy contacts is recommended for use as the main contactor. The coils must be specified at the nominal battery pack voltage, with a continuous rating.

A 500 $\Omega$  5W resistor must be used across the contactor to precharge the capacitors.

### *Keyswitch and Run/Store Switch*

The vehicle should have a keyswitch to enable/disable driving each time the vehicle is used. The run/store switch, on the other hand, is typically located in an out-of-the-way location and left on except when the vehicle will be stored (during the winter, for example) or is being towed. The keyswitch and the run/store switch provide current to drive the various coils as well as the controller's internal logic circuitry and must be rated to carry these currents.

### *Forward, Reverse, Mode Select, and Pedal Interlock Switches*

These input switches can be any type of single-pole, single-throw (SPST) switch capable of switching the battery voltage at 25 mA.

### *Circuitry Protection Devices*

To protect the control circuitry from accidental shorts, a low current fuse (appropriate for the maximum current draw) should be connected in series with the battery feed to the run/store switch. Additionally, a high current fuse should be wired in series with the main contactor to protect the motor, controller, and batteries from accidental shorts in the power system. The appropriate fuse for each application should be selected with the help of a reputable fuse manufacturer or dealer. The standard wiring diagrams (see pages 8, 9) show the recommended fuse locations.

### *Speed Sensor*

A speed sensor is required for use with any 1266 controller. The speed sensor must be of a pulse type, and must interface to the controller with an open collector NPN transistor output. The most common sensor type will be a Hall effect switch IC, such as the Allegro type UGN3132 or Micro Switch type SS11; these work with an eight-pole (four pulses per revolution) ring magnet attached to the motor shaft. Other pole configurations can be accommodated by programming the Tacho Poles parameter to match the sensor magnet. Linear output sensors such as PM tachogenerators and variable reluctance gear tooth sensors ("magnetic pickups") are unsuitable.

A Curtis Application Note is available with more detailed information on the speed sensor requirements.

# 3

## PROGRAMMABLE PARAMETERS

The 1266 controller's programmable parameters allow the vehicle's performance characteristics to be customized to fit the needs of individual vehicles or vehicle operators. Programming can be done with a 1311 handheld programmer or a 1314 PC Programming Station. The discontinued 1307 handheld programmer is also fully compatible with the 1266 controller.

Curtis offers two versions of the 1311 programmer: the 1311-1101 is the User programmer (which can adjust only those parameters with User access rights) and the 1311-4401 is the OEM programmer (which can adjust all the programmable parameters). Similarly, the 1314 PC Programming Station software is available in two versions: 1314-1101 and 1314-4401. See Appendix B for more information about the programmers.

The 1266 controllers allow operation in two distinct modes, Mode 1 and Mode 2. These modes can be programmed to provide two different sets of operating characteristics, which can be useful for operating in different conditions—such as slow precise indoor maneuvering in one mode, and faster, long distance, outdoor travel in the other mode.

Ten parameters can be configured independently in the two modes:

- Main Current Limit (M1, M2)
- Acceleration Rate (M1, M2)
- Deceleration Rate (M1, M2)
  
- Brake Minimum (M1, M2)
- Brake Maximum (M1, M2)
- Brake Map (M1, M2)
- Brake Start (M1, M2)
- Brake End (M1, M2)
  
- Forward Speed (M1, M2)
- Forward Field Minimum (M1, M2).

In the following descriptions, the 1266's parameters are grouped into categories of related parameters. **Many of the parameters are interdependent. In the descriptions in this section, these interdependencies are only briefly noted. For a more thorough discussion of how they work together, see Section 5: Tuning Guide.**

The parameter names are listed here in the abbreviated forms that appear on the handheld programmer's 14-character LCD screen. Not all of these parameters are available on all controllers; the parameters for any given controller are dependent on its specifications.

For a list of the parameters in the order in which they are displayed in the Program menu, see Appendix B.

For an alphabetical list and index of the parameters, see Appendix C.

**Acceleration Parameters**

ACCEL (M1, M2, REV)  
DECEL (M1, M2, REV)  
FLD BRAKE  
FLD BRAKE SPD  
FLD BRAKE MAX  
FLD BRAKE RATE

**Speed Parameters**

FWD SPEED (M1, M2)  
REV SPEED  
RPM TO SPEED  
TACHO POLES

**Throttle Parameters**

THROTTLE 0%  
THROTTLE 100%  
THROTTLE MAP  
THROT FAULT LO  
THROT FAULT HI

**Current Limit Parameters**

MAIN C/L (M1, M2)  
REGEN C/L  
PLUG C/L  
WALKAWAY C/L

**Brake Mapping Parameters**

BRAKE MIN (M1, M2, REV)  
BRAKE MAX (M1, M2, REV)  
BRAKE START (M1, M2, REV)  
BRAKE END (M1, M2, REV)  
BRAKE MAP (M1, M2, REV)

**Field Mapping Parameters**

FWD FLD MIN (M1, M2)  
REV FIELD MIN  
FIELD MAX  
NEG FIELD MAX  
FLD MAP START / NEG FLD MAP ST  
FIELD MAP END / NEG FLD MAP EN  
FIELD RAMP / NEG FLD RAMP

**Fault Parameters**

KSI SRO ENABLE  
MODE AFTER KEY  
OVERVOLTAGE  
LOW VOLTAGE  
WARNING OPTION

**Output Driver Parameters**

AUX DRVR MODE  
AUX PULL IN  
AUX HOLDING  
EMB DELAY  
EMB SPD CHECK  
EMB SPD VALUE

## Acceleration Parameters

### M1/M2/REV ACCEL RATE

The **acceleration rate** defines the time, in seconds, for the controller to accelerate from 0% output to 100% output. A larger value represents a longer acceleration time and a gentler start. Fast starts can be achieved by reducing the acceleration time, i.e., by adjusting the accel rate to a smaller value. The forward accel rate can be set independently for each of the two operating modes; the reverse accel rate applies to both M1 and M2.

### M1/M2/REV DECEL RATE

The **deceleration rate** defines the time, in seconds, for the controller to reduce the average voltage at the armature output from 100% PWM to 0% PWM. A larger value represents a longer deceleration time and gentler vehicle slowing. Quick stops can be achieved by reducing the deceleration time, i.e., by adjusting the decel rate to a smaller value. The forward decel rate can be set independently for each of the two operating modes; the reverse decel rate applies to both M1 and M2.

If the vehicle is slowing quicker than the decel rate (for example, at zero throttle, traveling up a hill) the output will decay at a rate of 0.8 seconds.

### FLD BRAKE

The **field brake** parameter enables or disables the field braking function. When set to On, the field brake routine is enabled and will increase the vehicle braking near zero speed.

*Related parameters:* When FLD BRAKE is On, the Field Brake SPD, MAX, and RATE parameters apply; they have no effect when FLD BRAKE is programmed Off.

### FLD BRAKE SPD

The **field brake speed** parameter sets the speed threshold below which field braking will occur when FLD BRAKE is On. When the throttle has been released and vehicle speed is detected to have fallen below FLD BRAKE SPD, the field current starts to increase toward the value specified by FLD BRAKE MAX at a rate specified by FLD BRAKE RATE. If the threshold speed is set very low, field braking will occur only at the very end of vehicle deceleration. If the vehicle does not slow to the speed defined by FLD BRAKE SPD (down a steep hill, for example) field braking will not occur as the threshold will not be reached.

## FLD BRAKE MAX

The **field brake max** parameter sets the maximum value of field current permitted during field braking when FLD BRAKE is On. The field current defined by FLD BRAKE MAX overrides the standard field map current below the speed defined by FLD BRAKE SPD.

When an EM brake is used, the amount of field current programmed by FLD BRAKE MAX is applied for the max amount of time specified by EMB DELAY (see Output Driver parameters) prior to locking the EM brake. A high value of FLD BRAKE MAX helps to ensure the vehicle uses sufficient braking to slow to a stop before locking the EM brake.

When the auxiliary output is used for a WalkAway relay™ instead of an EM brake, lower FLD BRAKE MAX values are useful in providing softer braking near zero speed. Setting the value too low may render the controller incapable of sensing vehicle rollback. However, even though the anti-rollback function may not be activated, the plug braking generated by the field current will still act to slow the vehicle.

## FLD BRAKE RATE

The **field brake rate** parameter defines how quickly the field current rises during field braking when FLD BRAKE is On, and is adjustable from 0 to 6. This index value defines the time for the field current to rise to the programmed FLD BRAKE MAX, as shown in the examples below. The higher the setting, the faster the rise. (In these examples, FLD BRAKE MAX = 50.0 amps.)

	INDEX	FIELD CURRENT RANGE	TIME OF RISE
STRONGER BRAKING ↓	1	0.0 – 50.0 A	3.2 seconds
	6	0.0 – 50.0 A	0.5 seconds

When an EM brake is used, the field current rises until it reaches FLD BRAKE MAX, maintains that current for the duration of EMB DELAY, at the end of which the EM brake driver turns off, causing the brake to engage—if it has not already been applied due to the vehicle having stopped or started to roll back.

## Speed Parameters

### M1/M2 FWD SPEED

The **forward speed** parameter defines the maximum speed limit in the forward direction. It is adjustable from 4.0 to 40.0, in units of mph or km/h (depending on RPM TO SPEED the setting).

### REV SPEED

The **reverse speed** parameter defines the maximum speed limit in the reverse direction. It is adjustable from 4.0 to 16.0, in units of mph or km/h (depending on RPM TO SPEED the setting).

### RPM TO SPEED

The **rpm to speed** parameter is a conversion factor used to generate a vehicle speed estimate from the speed sensor input (motor RPM signal). Use these equations to calculate the value to enter for RPM TO SPEED:

$$\text{For English units (mph): } \frac{\text{tire diameter (inches)}}{\text{gear ratio}} \times 63$$

$$\text{For metric units (km/h): } \frac{\text{tire diameter (cm)}}{\text{gear ratio}} \times 40$$

### TACHO POLES

The **tachometer poles** parameter configures the speed sensor, and should be set to the number of magnetic poles in the speed sensor magnet. TACHO POLES is adjustable from 4 to 20; see speed sensor description (page 14) for information about sensor types.

## Throttle Parameters

### THROTTLE 0%

The **throttle 0%** parameter defines the throttle input voltage at which a throttle command begins. Voltages lower than the programmed value (but higher than THRTL FAULT LO) are interpreted to be in a 0% deadband.

### THROTTLE 100%

The **throttle 100%** parameter defines the throttle input voltage that gives a full throttle command. Input voltages above this value (but lower than THRTL FAULT HI) are interpreted as 100% throttle command.

### THROTTLE MAP

The **throttle map** parameter modifies the vehicle's response to the throttle input. As shown in Figure 7, this parameter determines the controller output for a given amount of applied throttle. The THROTTLE MAP setting refers to the controller output at half throttle, the midpoint of the throttle's full active range (the range between THROTTLE 0% and THROTTLE 100%).

**Fig. 7** Throttle maps for controller with the Throttle Map parameter set at various values.

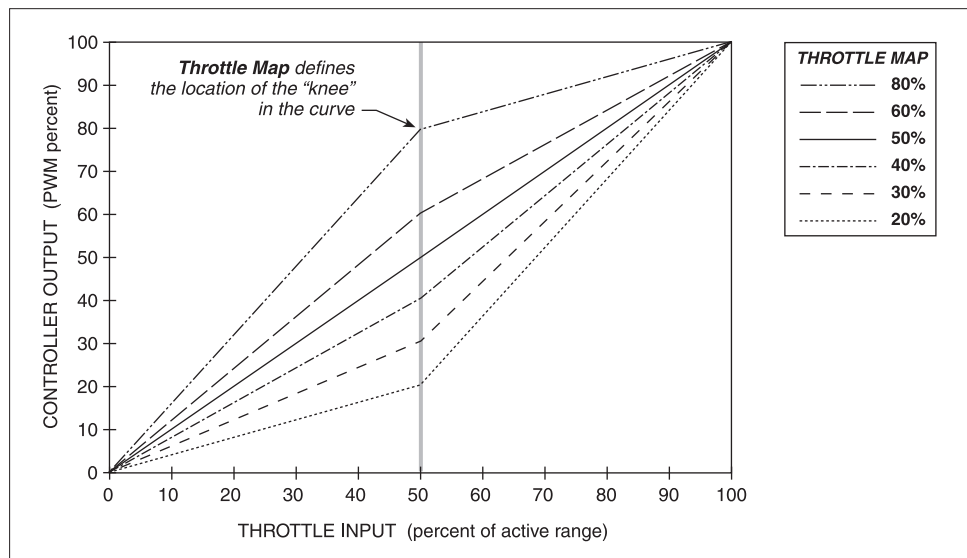

Setting THROTTLE MAP at 50% provides a linear output response to throttle position. Values below 50% reduce the controller output at low throttle settings, providing enhanced slow speed control. Values above 50% give the vehicle a faster, jumpier feel at low throttle settings.

Controller output begins when the throttle is moved beyond THROTTLE 0%, and continues to increase—following the curve defined by the THROTTLE MAP setting—as the throttle input increases, and reaches maximum output when the throttle input crosses the THROTTLE 100% threshold.

### THROT FAULT LO

The **throttle fault low** parameter sets the lower throttle fault threshold; throttle input voltages below this threshold will signal a throttle fault.

### THROT FAULT HI

The **throttle fault high** parameter sets the upper throttle fault threshold; throttle input voltages above this threshold will signal a throttle fault.

## *Current Limit Parameters*

### M1/M2 MAIN C/L

The **main current limit** parameter allows adjustment of the maximum current the controller will supply to the motor during drive operation. This parameter can be used to reduce the maximum torque applied to the drive system by the motor in either of the modes. The drive current limit is adjustable from 100 amps up to the controller's full rated current. The full rated current depends on the controller model.

### REGEN C/L

The **regenerative current limit** parameter allows adjustment of the maximum current the controller will supply to the motor during regen braking operation. During regen braking, this parameter controls the regen current from the motor's armature into the battery. The braking current limit is adjustable from 0 amps up to the controller's full rated current. The full rated current depends on the controller model.

Regen is the normal mode of braking.

### PLUG C/L

The **plug current limit** parameter allows adjustment of the maximum current the controller will supply to the motor during plug braking operation. During plug braking, this parameter controls the plug current from the motor's armature. The plug current limit is adjustable from 0 amps up to the controller's full rated current. The full rated current depends on the controller model.

Plug braking is used during WalkAway™ and Anti-Rollback operation.

### WALKAWAY C/L

The **WalkAway current limit** parameter sets the maximum field current applied during WalkAway™ operation. The WalkAway™ function applies field current to slow a vehicle that is detected as moving while the main contactor is open. The motor force created from this function is intended to limit the vehicle's rolling speed, but may not be sufficient to slow heavy vehicles on steep

slopes. The warning buzzer is pulsed to create an audible indication that the vehicle is rolling.

### **Brake Mapping Parameters**

The brake mapping parameters determine the maximum braking power that can be applied at a given vehicle speed. BRAKE MAX should be set higher than BRAKE MIN, and BRAKE END higher than BRAKE START.

#### **M1/M2/REV BRAKE MIN**

The **brake minimum** parameter sets the max regen current at low speeds, and is applicable from BRAKE START speed to zero speed. The value is a percentage of the full regen current.

BRAKE MIN is used to soften vehicle braking at low speeds. A low value will limit the braking at low speeds to provide a soft deceleration. A very low value may prevent the vehicle from coming to a stop from pedal-up braking on an incline, while a very high value may cause the vehicle to brake abruptly.

#### **M1/M2/REV BRAKE MAX**

The **brake maximum** parameter is used to set the max regen current at high speeds, and is applicable at speeds at and above the BRAKE END speed. The value is a percentage of the full regen current.

BRAKE MAX is used to strengthen vehicle braking at high speeds. A high value will provide greater braking power at high speeds. A very low value may prevent the vehicle from successfully limiting speed down a hill, while a very high value may cause excessive braking force at high speeds.

#### **M1/M2/REV BRAKE START**

The **brake map start** parameter defines the vehicle speed at which the brake map starts to increase from the BRAKE MIN value. Increasing the BRAKE START value increases the speed at which the controller's braking power reaches the BRAKE MIN setting, resulting in a larger speed range with soft braking.

#### **M1/M2/REV BRAKE END**

The **brake map end** parameter defines the vehicle speed at which the brake map reaches the BRAKE MAX value. This parameter can be set to allow the controller to use a higher braking power at higher speeds.

Decreasing the BRAKE END value increases the braking torque the vehicle can produce at medium speeds.

### M1/M2/REV BRAKE MAP

The **brake map** parameter defines the shape of the brake map curve. The value set for this parameter is a percentage of the regen current between the BRAKE MIN and BRAKE MAX values, at the point that is halfway between the BRAKE END and BRAKE START speeds (the “Brake Map Midpoint”), as shown in Figure 8.

The BRAKE MAP curve is the max allowed regen current, and the shaded gray area below it is the operating range.

**Fig. 8** Brake map structure.

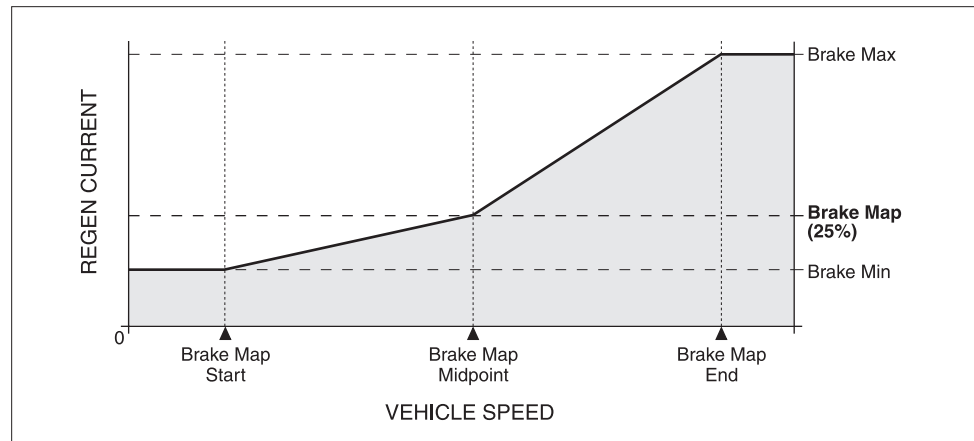

Note: Brake Map START and Brake Map END refer to the vehicle speeds at which the regen current “starts” to *increase* and “ends” *increasing*. From the operator’s perspective, however, braking begins at the point on the curve corresponding to the vehicle’s speed when braking is initiated, and then follows the curve toward “Brake Start.” The braking force is typically set to *decrease* as the vehicle slows down.

With the BRAKE MAP set at 50%, the motor’s regen current limit decreases linearly with decreasing speed (from BRAKE END to BRAKE START), providing a consistent rate of softening in braking power. Decreasing the BRAKE MAP setting reduces the regen current attainable at medium speeds. Because the regen current limit is reduced as the speed is reduced, the motor will brake more gently as the vehicle approaches a stop.

## Field Mapping Parameters

The field mapping parameters determine how much field current is applied for a given armature current.

### M1/M2 FWD FIELD MIN

The **forward minimum field current limit** parameter defines the minimum allowed current in the motor's field winding when the vehicle is traveling in the forward direction. Its setting may affect the vehicle's maximum speed and, to some extent, the smoothness with which the vehicle starts and transitions between drive and regen. If FWD FIELD MIN is set high, the vehicle's top speed will be reduced, but torque bumps may be evident when the vehicle is inched or changes direction.

One of the greatest advantages of the FIELD MIN parameter is that it will prevent uncontrolled acceleration when the vehicle goes down ramps or when it is unloaded from trucks, etc.

### REV FIELD MIN

The **reverse minimum field current limit** parameter defines the minimum allowed current in the motor's field winding when the vehicle is traveling in the reverse direction.

### FIELD MAX

The **maximum field current limit** parameter defines the maximum allowed current in the motor's field winding. Its setting will determine the motor's maximum torque during drive operation, and will limit the power dissipation in the field winding itself.

### NEG FIELD MAX

The **negative maximum field current limit** parameter defines maximum allowed current in the motor's field winding during regen braking.

### FLD MAP START / NEG FLD MAP ST

The **field map start** parameter defines the armature current at which the field current starts to increase from the FIELD MIN value (see current limit parameters). The **negative field map start** parameter works similarly; it defines the negative armature current at which the field current starts to increase from the FIELD MIN value.

Care should be taken to ensure that high FIELD MAP START values do not move the motor's operating characteristics outside its safe commutation area.

## FIELD MAP END / NEG FLD MAP EN

The **field map end** parameter defines the armature current at which the field map clamps to the FIELD MAX value (see current limit parameters).

Care should be taken to ensure that high FIELD MAP END values do not move the motor's operating characteristics outside its safe commutation region.

## FIELD RAMP / NEG FLD RAMP

The **field ramp** parameter defines the shape of the field map curve. It is set as a percentage of the field current between the FIELD MIN and FIELD MAX values.

As shown in Figure 9, the FIELD RAMP parameter sets the field current at the armature current that is halfway between the FIELD MAP START current and the FIELD MAP END current. This halfway point is referred to as the Field Map Midpoint.

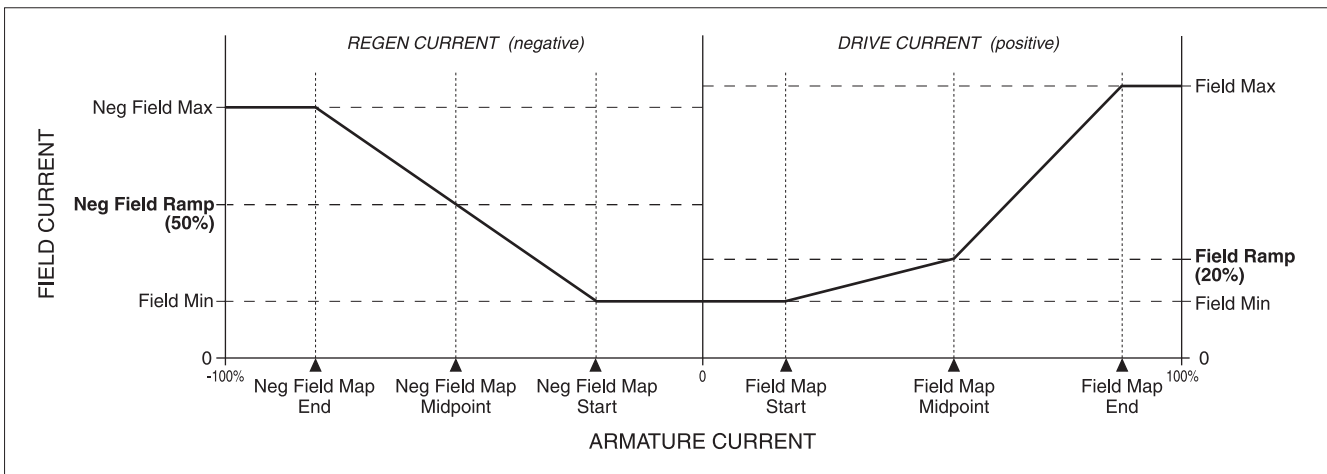

**Fig. 9** *Field map structure.*

With FIELD RAMP set at 50% and FIELD MAP START set at zero, the motor's field current increases linearly with increasing armature current—thus emulating a series wound motor. Decreasing the FIELD RAMP setting reduces the field current at a given armature current, i.e., it weakens the field. As the field current is reduced, the motor will be able to achieve higher speeds.

Care should be taken to ensure that excessively low FIELD RAMP values do not move the motor's operating characteristics outside its safe commutation region.

## **Fault Parameters**

### **KSI SRO ENABLE**

The **keyswitch static return to off (SRO)** feature prevents the vehicle from being started when “in gear.” When this parameter is enabled, the controller must initially sense the KSI input in the Off position (upon vehicle power-up) prior to it being switched to the On position. This feature is used to prevent vehicle motion due to a KSI short circuit or due to the keyswitch being permanently locked in the On position.

### **MODE AFTER KEY**

The **mode change after keyswitch** parameter determines whether the operating mode (M1, M2) can be changed after KSI has been activated. If MODE AFTER KEY is enabled, the mode can be changed while the vehicle is being operated. The settings are gradually slewed between the two modes so as to reduce the abruptness of the transition. However, if the settings for Mode 1 greatly differ from those of Mode 2, switching from one mode to the other while driving may cause the vehicle performance to change drastically.

If MODE AFTER KEY is not enabled, the mode can be changed only when keyswitch is off.

### **OVERVOLTAGE**

The **overvoltage** parameter sets the overvoltage protection threshold for the electronic system. This parameter determines when regen should be cut back to prevent damage to batteries and other electrical system components due to overvoltage.

A non-adjustable internal threshold also exists, to prevent damage within the controller.

### **LOW VOLTAGE**

The **low voltage** parameter sets the undervoltage threshold to protect the system from operating at voltages lower than its electronics were designed for. At this threshold voltage, the drive current will taper off until it reaches the controller’s internal threshold for safe operation. This will ensure proper operation of all electronics whenever the vehicle is driven.

## WARNING OPTION

The **warning option** parameter sets the output pattern—flash or solid—of the built-in LED and the warning beep conditions during anti-rollback and overvoltage. WARNING OPTION is programmable from 0 to 7:

SETTING	LED OUTPUT	ANTI-ROLLBACK BEEP	OVERVOLTAGE BEEP
0	flash	no	no
1	flash	no	yes
2	flash	yes	no
3	flash	yes	yes
4	solid	no	no
5	solid	no	yes
6	solid	yes	no
7	solid	yes	yes

## Output Driver Parameters

### AUX DRVR MODE

The **auxiliary driver mode** parameter determines whether the auxiliary function will be an electromagnetic brake or a WalkAway™ relay or neither (no auxiliary function). It is programmable from 0 to 2:

- 0 auxiliary driver Off
- 1 external WalkAway relay
- 2 electromagnetic brake

A WalkAway™ relay provides an alternative path for the current to the controller so that it can maintain braking to slow a vehicle that begins to roll after the main contactor has opened.

An EM brake keeps the vehicle from moving after coming to rest, which can be very useful when stopping on a hill.

Both options require appropriate hardware. See the wiring diagrams, pages 8 and 9.

### AUX PULL IN

The **auxiliary pull-in voltage** parameter sets the peak voltage momentarily applied to the load connected to the aux driver. The pull-in parameter allows a high initial voltage to be supplied for 0.1 second when the driver first turns on, to ensure proper closure. Values for this parameter should be determined from relay/EMB specifications or advice from the device manufacturer.

AUX PULL IN is programmable from 1 to 3, representing these fixed battery voltage percentages:

- 1 100% battery voltage
- 2 60% battery voltage
- 3 35% battery voltage

### AUX HOLDING

The **auxiliary holding voltage** parameter sets the continuous voltage applied to the load connected to the aux driver, after the initial 0.1 second pull-in.

AUX HOLDING is programmable from 1 to 3. The driver output is pulse width modulated at one of three battery voltage percentages:

- 1 100% battery voltage
- 2 60% battery voltage
- 3 35% battery voltage

Using this parameter, the average applied voltage can be reduced so that a coil that is not rated for the full battery voltage can be used. For example, a relay coil rated for 24V could be used in a 48V system if AUX HOLDING is set to 3 ( $48V * 0.35 = 16.8V$ ), as 16.8V is well above typical dropout voltage. The

resulting voltage must be set high enough to hold the relay closed under all shock and vibration conditions the vehicle will be subjected to. Low settings minimize the current required to power the coil, thereby reducing coil heating and increasing battery life.

Values for AUX HOLDING should be determined with specifications or advice from the relay or brake manufacturer.

*Example: To use a 24V brake in a 48V vehicle, try*

AUX PULL IN = 2 (28.8V)

AUX HOLDING = 3 (16.8V)

## EMB DELAY

The **electromagnetic brake dropout delay** sets a delay time before the EM brake drops. The delay countdown begins either (1) when the vehicle has come to rest and the main contactor has opened or (2) during field braking, when the vehicle has slowed below the FLD BRK SPD.

*Related parameter:* The FLD BRAKE parameter defines when the EM brake delay will begin—see (1) and (2) above.

## EMB SPD CHECK

The **electromagnetic brake speed check** parameter adds extra measures to prevent the locking of the EM brake at high vehicle speeds under conditions when the main contactor is open (for example, if the keyswitch is turned off during driving or a fault is detected). When it is enabled, the controller overrides the EMB DELAY in an attempt to allow the vehicle to slow down prior to engaging the EM brake.

## EMB SPD VALUE

The **electromagnetic brake at speed value** parameter sets the speed at which the EM brake is permitted to lock. It is programmable from 0 to 40.0 mph, and is typically set at the extreme low end of that range. The purpose of EMB SPD VALUE is to prevent dropping the EM brake at high speed, which could be dangerous on certain terrain (e.g., wet grass).

In the event of main contactor failure (or fault detection that commands the contactor to open) the EM brake parameters control the brake as follows.

EMB SPD CHECK = **off**

EM brake driver will turn off after EMB DELAY time has expired.

EMB SPD CHECK = **on**

EM brake driver will not turn off until vehicle speed is detected as having reduced to the set EMB SPD VALUE.

If EMB SPD VALUE is set below 1.0 mph, the EM brake driver will not turn off until the vehicle reaches rest.

## 4

## INSTALLATION CHECKOUT

Before operating the vehicle, carefully complete the following checkout procedure. If you find a problem during the checkout, refer to the diagnostics and troubleshooting section (Section 6) for further information.

The installation checkout can be conducted with or without the handheld programmer. The checkout procedure is easier with a programmer. Otherwise, observe the Status LED (located in the controller's label area) for diagnostic codes. The codes are listed in Section 6.



**Put the vehicle up on blocks to get the drive wheels up off the ground before beginning these tests.**

**Do not stand, or allow anyone else to stand, directly in front of or behind the vehicle during the checkout.**

**Make sure the keyswitch is off, the throttle is released, and the forward and reverse switches are open.**

**Wear safety glasses and use well-insulated tools.**

1. If a programmer is available, connect it to the programmer connector.
2. Turn the run/store switch on. The programmer should power up with an initial display. If it does not, check for continuity in the run/store switch circuit and controller ground.
 

If a programmer is not available, controller power-up can be verified by momentarily selecting reverse and listening for the sound of the reverse alarm.
3. If you are using a programmer, go to the Faults Menu. The display should indicate "No Known Faults."
 

If there is a problem, the LED will flash a diagnostic code and the programmer will display a diagnostic message. If you are conducting the checkout without a programmer, look up the LED diagnostic code in Section 6: Diagnostics and Troubleshooting.

When the problem has been corrected, it may be necessary to cycle the run/store switch in order to clear the fault.
4. Turn the keyswitch on, select a direction, and operate the throttle. The motor should begin to turn in the selected direction. If it turns in the wrong direction, first verify the wiring to the forward and reverse switches. If the wiring is correct, turn off the controller, disconnect the

battery, and exchange the motor's field connections (**F1** and **F2**) on the controller. The motor should now turn in the proper direction. The motor should run proportionally faster with increasing throttle. If not, refer to Section 6.

5. If you are using a programmer, go to the Monitor menu. Scroll down to observe the status of the switches:

Mode \*

Foot Input (pedal switch)

Key Input

Forward Input

Reverse Input

Mode Switch \*

Cycle each switch in turn, observing the programmer. The programmer should display the correct status for each switch.

\* “Mode Switch” tells you the physical status of the mode switch (open or closed). “Mode” is a monitor value that tells you the mode in which the vehicle is currently operating. This may not correspond to the status of the mode switch—for example, if the MODE AFTER KEY parameter is set to Off and the mode switch was flipped while the vehicle was being operated.

6. Take the vehicle down off the blocks and drive it in a clear area. It should have smooth acceleration and good top speed. Recommended procedures for tuning the vehicle's driving characteristics are presented in Section 5: Tuning Guide.
7. Test the deceleration and braking of the vehicle.
8. Verify that all options, such as static return to off (SRO), electromagnetic brake (or WalkAway™), and reverse signal are as desired.
9. If you used a programmer, disconnect it when you have completed the checkout procedure, to minimize battery discharge.

# 5

## TUNING GUIDE

The 1266 controller is a very powerful vehicle control system. Its wide variety of adjustable parameters allow many aspects of vehicle performance to be optimized. This section provides explanations of what the major tuning parameters do and instructions on how to use these parameters to optimize the performance of your vehicle. Once a vehicle/motor/controller combination has been tuned, the parameter values can be made standard for that system or vehicle model. Any changes in the motor, the vehicle drive system, or the controller will require that the system be tuned again to provide optimum performance.

The tuning procedures should be conducted in the sequence given, because successive steps build upon the ones before. The tuning procedures instruct personnel how to adjust various programmable parameters to accomplish specific performance goals. It is important that the effect of these programmable parameters be understood in order to take full advantage of the 1266 controller's powerful features. Please refer to the descriptions of the applicable parameters in Section 3 if there is any question about what any of them do.

### MAJOR TUNING

Five major performance characteristics are usually tuned on a vehicle:

- ① Tuning the Active Throttle Range
- ② Calibrating the Controller Speed Measurement
- ③ Tuning the Controller to the Motor (Field Mapping)
- ④ Equalizing Loaded/Unloaded Vehicle Speed on Flat Ground
- ⑤ Confirming Loaded Vehicle Speed on Downhill Grade.

These five characteristics should be tuned in the order listed.

#### ① Tuning the Active Throttle Range

Before attempting to optimize any specific vehicle performance characteristics, it is important to ensure that the controller input is operating over its full range. To do this, the throttle should be tuned using the 1311 handheld programmer and a voltmeter. The procedures that follow will establish zero throttle, full throttle, and throttle fault parameter values that correspond to the absolute full range of your particular throttle mechanism. Note: These parameters are expressed in absolute voltages between 0 and 5 volts.

It is advisable to provide some buffer around the absolute full range of the throttle mechanism to allow for throttle resistance variations over time and temperature as well as variations in the tolerance of potentiometer values between individual throttle mechanisms. This will form areas at the top and bottom of the throttle movement range that the controller reads as 0% and 100%.

- 
- STEP 1. Jack the vehicle wheels up off the ground so that they spin freely. Note: Most of the throttle tuning can be done without driving the motor, but it is advisable to check that the throttle range is still fully active when motor currents are being produced.
- STEP 2. Plug the 1311 programmer into the controller and turn on the controller with the run/store switch.
- STEP 3. Using the programmer's Program menu, initially set the THROTTLE MAP parameter to 50%. This will provide a linear relationship between the throttle input voltage and the Throttle % displayed in the programmer's Monitor menu.
- STEP 4. Select the Monitor menu. Throttle % should be visible at the top of the display. You will need to reference the value displayed here.
- STEP 5. Use a voltmeter and test clip to measure the throttle input voltage at Pin 5.
- STEP 6. Measure and note the voltage when the throttle is fully released.
- STEP 7. If the pedal switch is wired into the mechanical throttle mechanism, scroll down the Monitor menu to Foot Input. The display should indicate that the pedal switch is Off. Slowly apply throttle until the display indicates that the pedal switch is On. Measure the throttle voltage that is being produced at this threshold, and make a note of this value.
- STEP 8. Measure the voltage when the throttle is fully depressed, and make a note of this value.
- STEP 9. Return to the Program menu.  
Set THROT FAULT LO lower than the fully released voltage measured in Step 6.  
If the pedal switch is wired into the throttle mechanism, set THROTTLE 0% close to the voltage measured in Step 7. (Setting THROTTLE 0% too far below this voltage will result in loss of low-end throttle range.) If the pedal switch is *not* part of the throttle assembly, set THROTTLE 0% above the fully released voltage measured in Step 6.  
Set THROTTLE 100% lower than the fully depressed voltage measured in Step 8. Set the THROT FAULT HI parameter above the fully depressed voltage (but no higher than 4.7 V).
- STEP 10. Apply the keyswitch and forward switch and depress the throttle slowly through the full range of motion, causing the wheels to spin. Ensure that the Throttle % reaches 100% when the pedal is fully depressed. Ensure that the Throttle % returns to 0% when the throttle is released and that no throttle fault appears in the Faults menu.
- STEP 11. Refer to Section 3, page 20, and set the THROTTLE MAP parameter for desired performance.

## ② Calibrating the Controller Speed Measurement to the Vehicle

The RPM TO SPEED parameter is a conversion factor used to generate a vehicle speed estimate from the speed sensor input (motor RPM signal). This conversion factor allows the vehicle to be configured for various gear ratios and tire sizes. It can also be used to convert the displayed vehicle speed values (in the Program and Monitor menus) between English and metric units. Use the equations below to calculate the correct value for this parameter.

$$\text{For English units (mph): } \frac{\text{tire diameter (inches)}}{\text{gear ratio}} \times 63$$

$$\text{For metric units (km/h): } \frac{\text{tire diameter (cm)}}{\text{gear ratio}} \times 40$$

- STEP 1. Using the Program menu, set RPM TO SPEED to the correct value for the vehicle tire size and gear ratio.
- STEP 2. Set TACHO POLES To the number of poles in the motor's speed sensor (typically 8).
- STEP 3. Set the M1 FWD SPEED, M2 FWD SPEED and REVERSE SPEED to the desired top vehicle speeds (in either mph or km/h).

## ③ Tuning the Controller to the Motor

The 1266 controller has the flexibility to be tuned to nearly any separately excited motor from any manufacturer. The programmable parameters allow full control of the motor's maximum armature current during driving and braking; they also allow full control of the motor's maximum and minimum field current as well as the field current relationship to the armature current. This flexibility allows motor performance to be maximized while protecting it from operating outside its safe commutation region.

In order to properly tune the controller, the following information should be obtained from the motor manufacturer:

- Maximum Armature Current Rating
- Maximum Field Current Rating
- Minimum Field Current Rating
- Field Resistance (hot and cold)
- Positive and Negative Field Maps.

The performance of a separately excited motor changes depending on temperature. This is due to the change in field winding resistance as the motor heats up through use. When the field winding temperature increases, so does its resistance and therefore the maximum current that can be forced through

the winding is reduced. Reductions in the field current over the motor's typical operating temperature range can be 10% to 50%. Since the maximum available field current determines the maximum torque that can be produced by the motor, the vehicle's performance under load and up inclines will change as the motor heats up. The change in performance can be limited by tuning the motor when it is hot rather than cold. We therefore recommend that this procedure be performed with a hot motor.

- STEP 1. Using the programmer's Program Menu, set the drive current limit (MAIN C/L) for both modes to the smaller of: (a) the motor's peak armature current rating, or (b) the maximum controller drive current limit. This value can later be adjusted to establish the desired vehicle driving feel in each mode.
- STEP 2. Set the REGEN C/L value in each mode to the smaller of: (a) the maximum motor armature current rating, or (b) the maximum controller braking current limit. This value can later be adjusted to establish the desired vehicle braking feel (see Fine Tuning).
- STEP 3. To set FIELD MAX, first decide whether you want to maintain consistent vehicle operation throughout the motor's temperature range. If you do, proceed to Step 4. If, however, maintaining operational consistency across motor temperature is **not** a concern and achieving maximum torque **is**, skip to Step 5.
- STEP 4. For the most consistent operation across temperature, set the FIELD MAX to the maximum field current available at low battery voltage with a hot motor. To determine this current, divide the **low battery voltage** (typically 70% of nominal) by the **high temperature** field winding resistance specification provided by the manufacturer. Set FIELD MAX to this value. This will provide good consistency between motor performance in both hot and cold states. Skip to Step 6.
- STEP 5. For the maximum torque regardless of temperature, set FIELD MAX to the motor's rated absolute maximum field current. To determine the absolute maximum field current, divide the **nominal battery voltage** by the **low temperature** field winding resistance specification provided by the manufacturer. Set FIELD MAX to this value. This will provide the maximum possible torque under all conditions.

This has now set the FIELD MAX parameter.

The next step is to set the FIELD MIN parameter. **FIELD MIN should never be set below the rated value specified by the manufacturer.** Operating the motor at lower field currents than specified will result in operation outside the motor's safe commutation region and will cause arcing between the brushes and commutator, significantly reducing motor and brush life.

STEP 6. Set NEG FIELD MAX at or below the FIELD MAX setting.

If the controller is tuned such that the system is operating outside the motor's safe commutation region, there will be audible and visual indications. Under normal operation, the motor will emit a whine with a pitch that increases with increasing rotation speed. If a "scratchy" sound is also heard, this is usually an indication that pin arcing is occurring in the motor and it is operating outside its safe commutation region. This operation is normally accompanied by a strong smell from the motor. If the brushes and commutator bars are visible, arcing may be visible. The further outside the safe commutation region the motor is operating, the worse the arcing will be. **Operation outside the safe commutation region is very detrimental to the motor.** The FIELD MIN and possibly also the FIELD RAMP should be increased until the indications of arcing stop. Decreasing FIELD MAP START will also help to move operation back into the safe commutation region.

The typical default field map settings are as follows.

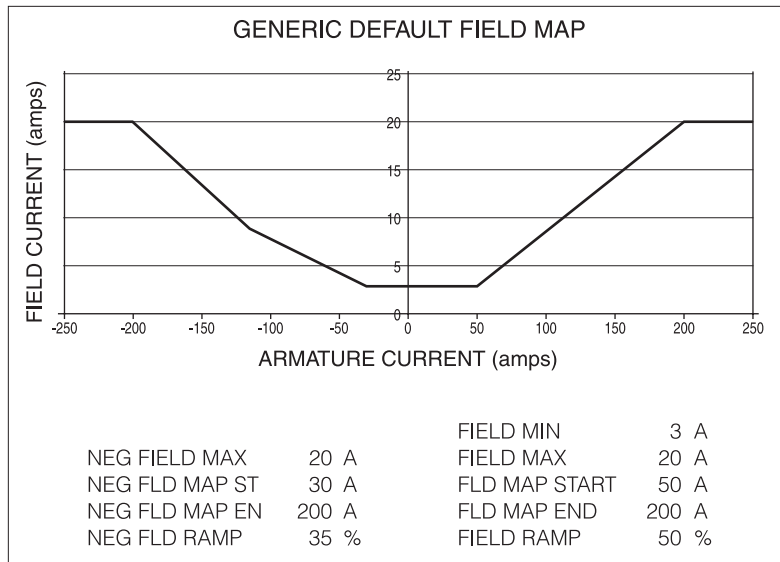

Further tuning of the field maps is described in procedures ⑤, ⑦, and ⑨.

#### ④ Equalizing the Loaded/Unloaded Vehicle Top Speed on Flat Ground

The controller and vehicle should be configured as follows prior to setting the maximum vehicle speed:

- DRIVE C/L as established in tuning procedure ③
- FIELD RAMP = 50%
- FLD MAP START = 20% of the specified drive current limit
- FIELD MIN = manufacturer's specified minimum or 3 amps
- The vehicle can be loaded or loaded

If full closed loop speed control is required in both loaded and unloaded operation, conduct this procedure with the vehicle loaded.

- The vehicle battery should be fully charged.

Drive the vehicle on a flat surface in a clear area during this procedure. Precautions should be taken to ensure safety of test personnel and anyone in the test area.

STEP 1. Select the programmer's Program menu and scroll down until M1 FWD SPEED parameter is displayed, and set this to the desired top forward speed for Mode 1. Confirm that Mode 1 is selected by reading the Mode value in the Monitor menu.

STEP 2. Turn on the keyswitch and the Forward switch and apply full throttle. While driving the vehicle with full throttle applied, observe the Speed In and Arm PWM readings in the Monitor menu. (Note: vehicle speed will display as 0.8 for speeds below 1.0.)

If the speed is being limited by the field map parameters, the Arm PWM will be 100%. In this case, skip to Step 4.

If the vehicle is truly in closed loop speed control, the Arm PWM will be less than 100%. The controller will be limiting the vehicle speed to the programmed maximum speed by reducing the applied armature voltage below the value commanded by the throttle. In this case, proceed to Step 3.

STEP 3. Observe the Arm PWM and Arm Current readings while driving at top speed. Set the FLD MAP START to a value above the Arm Current reading. With the vehicle unloaded, increase the M1 FWD FLD MIN until the Arm PWM is between 60–70%. When the vehicle is loaded the controller will output a higher value of Arm PWM to achieve this speed.

For slow speeds, a higher FIELD MIN is preferable, in order to ensure a smooth transition between the drive and regen states. For high speeds, a lower FIELD MIN is usually necessary to allow the vehicle to achieve true closed loop speed control and not be limited by the field current.

Skip to Step 5.

STEP 4. In this case, the vehicle's top speed is being limited by the field mapping parameters. Observe the Arm Current in the Monitor menu, and set the FIELD MAP START to a value above the Arm Current reading. Reduce the M1 FWD FLD MIN until the Speed Input shows the programmed maximum speed (i.e., the speed set by M1 FWD SPEED) and the Arm PWM reading drops below 100%, indicating that the controller is in closed loop speed control. When the vehicle is unloaded the controller will output a lower value of Arm PWM to maintain this speed.

Do not set the field mapping parameters outside the motor's safe commutation limits.

STEP 5. Repeat from Step 1 for the Mode 2 forward speed and for reverse speed. Separate field minimum parameters are provided for all three speeds (M1 FWD SPEED, M2 FWD SPEED, REV SPEED).

### ⑤ Confirming Loaded Vehicle Speed on Downhill Grade

STEP 1. Set the following parameters:

- REGEN C/L = maximum specified by the motor specs
- NEG FLD MAP EN = at or below REGEN C/L
- NEG FIELD MAX = FIELD MAX (as set in procedure ③, step 6)
- M1 BRAKE END = at least 1–2 mph or km/h below M1 FWD SPEED
- M1 BRAKE MAX = 100%.

STEP 2. With the vehicle fully loaded, drive down the steepest required grade. Observe the Arm Current displayed in the Monitor menu (it will be a negative value). This value is the regen current required to prevent exceeding the programmed top speed. It is an important value to be aware of when adjusting the brake mapping parameters for optimum compression braking feel.

If the vehicle top speed is exceeded, increase the NEG FIELD MAX and NEG FLD RAMP or decrease NEG FLD MAP EN to help provide additional braking torque earlier.

See brake mapping examples on page 41.

STEP 3. Repeat the procedure for the Mode 2 forward speed and for reverse speed. Separate brake mapping parameters are provided for each speed (M1 FWD SPEED, M2 FWD SPEED, REV SPEED).

## FINE TUNING

Seven additional vehicle performance characteristics can be adjusted:

- ⑥ Response to Increased Throttle
- ⑦ Response to Full Throttle Release (Compression Braking)
- ⑧ Transitioning from Flat Ground to Downhill
- ⑨ Hill Climbing
- ⑩ WalkAway™ Braking
- ⑪ Low-Speed Field Braking
- ⑫ Applying the EM Brake.

These characteristics are related to the “feel” of the vehicle and will be different for various applications. Once the fine tuning has been accomplished, it should not have to be repeated on every vehicle.

### ⑥ Response to Increased Throttle

The vehicle’s response to throttle increases can be modified using the ACCEL, THROTTLE MAP, and FIELD MAX parameters. Optimal vehicle response is tuned by adjusting these parameters and then accelerating the vehicle from a dead stop under various throttle transition conditions.

- STEP 1. Set THROTTLE MAP as desired. In most applications a setting below 50% is used to provide greater control for low-speed maneuvering.
- STEP 2. Select Mode 1. While driving the vehicle, adjust M1 ACCEL for the best overall acceleration response. If the vehicle starts too slowly under all driving conditions, M1 ACCEL should be reduced. (Remember, the accel rate parameter is in units of time.)
- STEP 3. *Increasing vehicle acceleration.* If acceleration feels good for slow or moderate throttle transitions but the vehicle initially starts too slowly, set FIELD MAX higher. If acceleration is not satisfactory when the throttle is transitioned quickly from zero to full speed, decrease M1 ACCEL to obtain the desired fast throttle response.
- STEP 4. *Achieving better control at low speeds.* If the vehicle responds well for fast, full range throttle transitions but is too jumpy during low speed maneuvering, reduce the THROTTLE MAP.
- STEP 5. Select Mode 2 and repeat the procedure.

You may wish to dedicate one of the two modes for precision maneuvering. The ACCEL, MAX SPEED, and MAIN C/L parameters can be tuned exclusively for this precision-maneuvering mode to obtain comfortable vehicle response. Because THROTTLE MAP and FIELD MAX are not mode-specific, you may need to re-tune Mode 1 if you make adjustments to these two parameters when tuning Mode 2.

## ⑦ Response to Full Throttle Release (Compression Braking)

The way the vehicle responds when the throttle is completely released can be modified using the DECEL, REGEN C/L, brake mapping, and negative field mapping parameters. Braking parameters should be set for M1 and M2 forward speeds and for reverse speed.

When the throttle is released, the DECEL rate acts to drive the armature PWM down to zero, but the BRAKE MAP will ensure that the braking (regen) current is limited to the value for the present vehicle speed. This allows a profile to be specified that allows high initial braking torque, softening to a milder torque as the vehicle slows down. Alternatively, you can set up a profile with strong braking down to zero speed. A lower DECEL value will also provide a more immediate strong braking feel.

- STEP 1. Set the brake mapping parameters to the default values shown in Example A on the next page.

Note: With the default settings, maximum braking torque is specified at top speed, tailing off to a much milder torque at low speeds.

- STEP 2. Drive the vehicle at full speed on flat ground and release the throttle, paying attention to the feel of vehicle braking. If the initial braking is too sudden, increase the DECEL value. If the initial braking is too strong, lower the BRAKE MAX or increase the BRAKE MAP END.

When setting a very mild compression braking feel, beware of setting the BRAKE MAX and REGEN C/L to values that will inhibit the controller's ability to maintain top speed braking—in both throttle applied and throttle released conditions—on a downhill grade.

If the braking torque remains too strong after the vehicle has been brought to a slower speed, reduce the BRAKE MAP and BRAKE MIN parameters, and increase the BRAKE MAP START. These adjustments will act to limit the braking torque at the lower speeds.

If, on the other hand, you want to *increase* braking torque at lower speeds, increase the BRAKE MAP or BRAKE MIN parameters, or reduce the BRAKE MAP START.

Note: The setting of the brake mapping and DECEL parameters will also affect the feel of the vehicle deceleration during partial throttle releases. After completing procedure ⑦ for full throttle release, make sure the deceleration during partial throttle release is acceptable.

**Example A: GENERIC DEFAULT BRAKE MAP**

*This map has strong high-speed braking torque, and mild low-speed braking torque.*

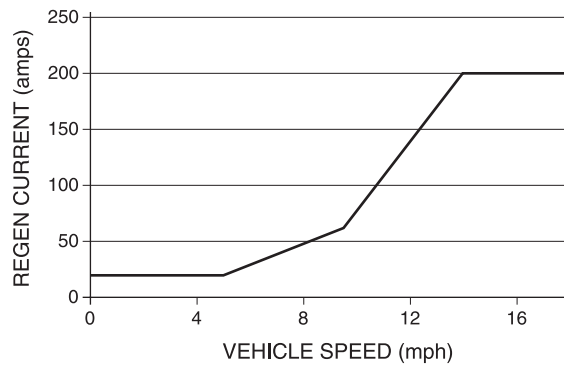

REGEN C/L	200 A
M1 FWD SPEED	16 mph
M1 BRAKE MIN	10 % (20 A)
M1 BRAKE MAX	100 % (200 A)
M1 BRAKE START	5 mph
M1 BRAKE END	14 mph
M1 BRAKE MAP	22 % (60 A)

**Example B**

*This map has strong braking to vehicle rest.*

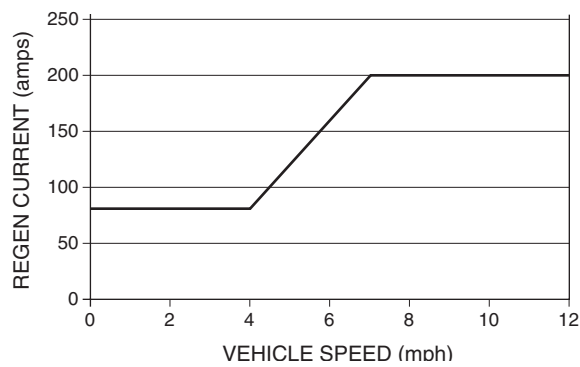

REGEN C/L	200 A
M1 FWD SPEED	10 mph
M1 BRAKE MIN	40 % (80 A)
M1 BRAKE MAX	100 % (200 A)
M1 BRAKE START	4 mph
M1 BRAKE END	7 mph
M1 BRAKE MAP	50 % (140 A)

**Example C**

*This map has mild top-speed braking.*

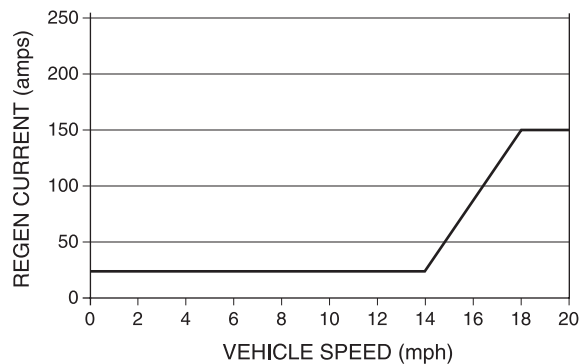

REGEN C/L	160 A
M1 FWD SPEED	16 mph
M1 BRAKE MIN	15 % (24 A)
M1 BRAKE MAX	100 % (160 A)
M1 BRAKE START	14 mph
M1 BRAKE END	18 mph
M1 BRAKE MAP	50 % (92 A)

Note: BRAKE MIN and BRAKE MAX are percentages of REGEN C/L.  
BRAKE MAP is a percentage of the range between BRAKE MIN and BRAKE MAX.

## ⑧ Transitioning from Flat Ground to Downhill

To ensure smoothness on transitions from positive drive current to negative regen current, set the NEG FLD MAP ST (negative field map start) greater than zero to provide a constant value of field current as the motor transitions between drive and regen braking.

If speed “hunting” or oscillation occurs on downhill grades, reduce the NEG FIELD MAX and NEG FLD RAMP parameters or increase the NEG FLD MAP EN parameter to ensure an initially shallower negative field map profile.

Note: The “negative field map” refers to the field and armature (regen braking) current relationship regardless of forward or reverse direction.

## ⑨ Hill Climbing

The vehicle response to increased gradients such as hills and loading ramps can be tuned via the FIELD RAMP parameter. Decreasing the FIELD RAMP value allows faster vehicle speeds while climbing, but it will also have the effect of reducing the ability of the controller to generate torque in the vehicle’s mid range speeds.

- STEP 1. If faster vehicle speed is desired when climbing ramps, decrease FIELD RAMP until the desired ramp climbing speed is attained. It should be noted that if the motor’s torque capability is exceeded under the conditions of load and ramp gradient, vehicle speed will be limited by the motor’s capability and the desired vehicle speed may not be attainable. The system will find a compromise point at which sufficient motor torque is generated to climb the ramp at an acceptable speed. If FIELD RAMP is reduced to 0% and the desired speed is still not attained, the system is being limited by the motor’s torque capability under these conditions.

Caution should be used in reducing FIELD RAMP since at low FIELD RAMP values it is possible that the motor could be operated outside its safe commutation region.

- STEP 2. If the drive system cannot produce sufficient torque for a fully loaded vehicle to climb the desired ramp, try increasing the FIELD RAMP, FIELD MAX, and/or MAIN C/L. The impact of increasing these values on other driving characteristics must be evaluated. Increasing the FIELD MAX will provide more field current, and increasing the MAIN C/L will provide more armature current. If FIELD MAX is set at the manufacturer’s specified limit and the MAIN C/L is set at the rated maximum, then vehicle speed up the ramp is limited by the motor or the vehicle’s gearing and cannot be increased by tuning the controller.

Note: To determine whether the controller’s armature current is at its set value during ramp climbing, read the Arm Current in the programmer’s Monitor menu.

### ⑩ WalkAway™ Braking

If the WalkAway™ option is configured, WalkAway™ braking will occur whenever vehicle movement is detected while the main contactor is open. In general this is used to prevent uncontrolled vehicle rolling after the vehicle has reached rest. It also is used to slow the vehicle if it is rolling when the keyswitch is turned off or in certain fault conditions that cause the main contactor to open.

The strength of the WalkAway™ braking is controlled by the WALKAWAY C/L and PLUG C/L parameters.

STEP 1. Drive the vehicle onto a steep grade, and hold it with the foot brake until you hear the main contactor open.

STEP 2. Release the foot brake. The vehicle will begin to roll at a slow pace, followed by WalkAway™ braking (indicated by a beeping tone).

If the vehicle is rolling too fast, increase the WALKAWAY C/L and/or the PLUG C/L.

STEP 3. Check that these braking parameter adjustments do not make the braking feel too abrupt on milder slopes.

### ⑪ Low-Speed Field Braking

The FLD BRAKE parameter provides an additional mechanism for slowing the vehicle down at slow speeds. There are three uses for field braking:

- a. Providing extra braking torque as the vehicle slows to a stop.
- b. Strengthening the anti-rollback braking in vehicles that do not have an EM brake.

Note: The anti-rollback function can never hold a vehicle perfectly stationary on an incline and is not intended to replace a mechanical or electromagnetic brake for this purpose. However, it will prevent uncontrolled vehicle coasting in this situation.

- c. On vehicles equipped with an EM brake, field braking and the EM brake can be used together to stop the vehicle and to prevent the vehicle from rolling back down a hill.

Note: This use of field braking is covered separately in Procedure ⑫.

This procedure tunes the field braking parameters to provide additional braking at low speeds in situations (a) and (b).

STEP 1. Set the following parameters:

- FLD BRAKE = On
- FLD BRAKE MAX = FIELD MIN
- FLD BRAKE SPD = a low value (e.g., 3 mph)
- FLD BRAKE RATE = 2.

STEP 2. Drive the vehicle up a grade.

STEP 3. Release the throttle. The vehicle will slow down and then roll back down the hill under gravity. Depending on the setting of the WARNING OPTION parameter, you may hear beeping.

If the vehicle is rolling too fast, increase the FLD BRAKE MAX setting. This will cause a higher plug braking current. It will also increase the braking feel as the vehicle initially slows down before changing direction.

To make the low-speed braking occur earlier, increase the FLD BRAKE SPD.

To increase the strength of the low-speed braking as the vehicle is brought to a stop, increase the FLD BRAKE RATE and FLD BRAKE MAX.

STEP 4. Drive the vehicle on flat ground to confirm that the extra braking feel provided by these adjustments is acceptable.

## ⑫ **EM Brake Operation** (with optional EM brake)

During normal operation, the EM brake is applied at the expiration of the EMB DELAY. The FLD BRAKE setting (Off or On) determines when the EMB DELAY countdown begins.

Note: For EM brake control during fault conditions, see EMB SPD VALUE, page 29.

(1) FLD BRAKE = Off

Here the EMB DELAY sets the length of time between the main contactor opening and the EM brake being applied.

STEP 1. Set the following parameters:

- FLD BRAKE = Off
- EMB DELAY = <1.0 second

(2) FLD BRAKE = On

Here the EMB DELAY sets the length of time the field current is held at the FLD BRAKE MAX before the EM brake is applied. This guarantees that the EM brake will be applied some time after the vehicle has slowed below the FLD BRAKE SPD (even though the main contactor may still be closed) and is useful in preventing the vehicle from continuing to roll forward. Additionally, if the controller

detects that the vehicle has reached rest, or is starting to roll back, the EM brake will be applied immediately to prevent further vehicle movement.

STEP 1. Set the following parameters:

- FLD BRAKE = On
- EMB DELAY = a low value (e.g., 3 seconds)
- FLD BRAKE MAX = FIELD MIN, or higher
- FLD BRAKE RATE = a low value (e.g., 2).

STEP 2. Drive up a hill and release the throttle. The vehicle should slow to a stop and the EM brake should drop just as the vehicle begins to roll backwards. If the vehicle rolls backwards excessively, increase the FLD BRAKE MAX.

STEP 3. Drive down a mild slope and release the throttle. The vehicle will slow down but may not reach a complete stop depending on the gradient of the slope. You should feel the field braking torque, followed by the EM brake being applied. If the EM brake is applied too early, increase the FLD BRAKE MAX and the EMB DELAY.

STEP 4. After adjusting these parameters, drive the vehicle on flat ground to confirm that the EM brake timing is acceptable. To avoid unnecessarily abrupt stops, the parameters should be set so that when driving on flat ground the vehicle reaches rest before the EM brake is applied.

# 6

## DIAGNOSTICS AND TROUBLESHOOTING

The 1266 controller provides diagnostics information to assist technicians in troubleshooting drive system problems. This information is displayed on the handheld programmer (or PC Programming Station), and it is also available in the form of fault codes issued by the controller's built-in Status LED. Refer to the troubleshooting chart for suggestions covering a wide range of possible faults.

### PROGRAMMER DIAGNOSTICS

The programmer presents complete diagnostic information in plain language. Faults are displayed in the Faults menu (see column 2 in the troubleshooting chart), and the status of the controller inputs/outputs is displayed in the Monitor Menu.

Accessing the Fault History menu provides a list of the faults that have occurred since the fault history file was last cleared. Checking (and clearing) the fault history file is recommended each time the vehicle is brought in for maintenance.

The following 4-step process is recommended for diagnosing and troubleshooting an inoperative vehicle: (1) visually inspect the vehicle for obvious problems; (2) diagnose the problem, using the programmer; (3) test the circuitry with the programmer; and (4) correct the problem. Repeat the last three steps as necessary until the vehicle is operational.

**Example:** A vehicle that does not operate in “forward” is brought in for repair.

STEP 1: Examine the vehicle and its wiring for any obvious problems, such as broken wires or loose connections.

STEP 2: Connect the programmer, select the Faults menu, and read the displayed fault information. In this example, the display shows “No Known Faults,” indicating that the controller has not detected any problems.

STEP 3: Select the Monitor menu, and observe the status of the inputs and outputs in the forward direction. In this example, the display shows that the forward switch did not close when “forward” was selected, which means the problem is either in the forward switch or the switch wiring.

STEP 4: Check or replace the forward switch and wiring and repeat the test. If the programmer shows the forward switch closing and the vehicle now drives normally, the problem has been corrected.

## TROUBLESHOOTING CHART

LED CODE	PROGRAMMER LCD DISPLAY	EXPLANATION	POSSIBLE CAUSE
1,1	HW FAILSAFE	Self-test or watchdog fault.	1. Controller defective.
1,2	THROTTLE FAULT 1	Wiper signal out of range (pot low fault).	1. Throttle input wire open. 2. Throttle input wire shorted to B+ or B-. 3. Throttle pot defective.
1,3	SPEED SENSOR FAULT	No pulses from sensor.	1. Speed sensor not connected. 2. Speed sensor defective.
1,4	HPD	High Pedal Disable fault.	1. Improper sequence of direction and throttle inputs.
1,5	MOTOR STALL	Motor stall at current.	1. Slope too steep for vehicle weight. 2. Mechanically locked motor. 3. EM brake wiring failure. 4. Speed sensor defective.
2,1	LOW BATTERY VOLTAGE	Low battery voltage.	1. Battery voltage < undervoltage cutback threshold. 2. Corroded battery terminal. 3. Loose battery or controller terminal.
2,2	OVERVOLTAGE	Overvoltage.	1. Battery voltage > overvoltage shutdown threshold. 2. Vehicle operating with charger attached. 3. Battery disconnected during regen braking.
2,3	THERMAL CUTBACK	Over-/undertemperature cutback.	1. Temperature > 85°C or < -25°C. 2. Excessive load on vehicle. 3. Improper mounting of controller 4. Operation in extreme environments.
2,4	MAIN DRIVER ON	Main contactor coil held low.	1. Main contactor missing or wire to coil open. 2. Controller defective.
2,5	AUX COIL FAULT	Missing aux (brake, relay) coil.	1. Aux coil open or not connected. 2. Breaker/fuse tripped or open. 3. Breaker/fuse defective.
3,1	MAIN DRIVER OFF	Main contactor driver held high.	1. Main contactor coil shorted. 2. Controller defective.
3,2	MAIN WELDED	Main contactor welded.	1. Main contactor stuck closed. 2. Main contactor driver shorted.
3,3	PRECHARGE FAULT	Internal voltage too low at startup.	1. External precharge resistor missing. 2. External short, or leakage path to B- on external B+ connection. 3. Controller defective.
3,4	FIELD MISSING	Field winding fault.	1. Motor field wiring loose. 2. Motor field wiring open.
3,5	AUX DRIVER OFF	Aux (brake, relay) driver held high.	1. Aux coil shorted. 2. Controller defective.
4,1	CURRENT SENSE FAULT	Armature or field current sensor fault.	1. Controller defective.
4,2	DRIVER OVERCURRENT	Contactor driver or aux driver overcurrent.	1. Contactor or aux coil shorted.

**TROUBLESHOOTING CHART, cont'd**

LED CODE	PROGRAMMER LCD DISPLAY	EXPLANATION	POSSIBLE CAUSE
4,3	M- SHORTED	Internal M- short to B-.	1. Controller defective.
4,4	AUX RELAY DNC	Aux relay did not close.	1. Aux relay missing or wire to coil open.
4,5	WELDED AUX RELAY	Welded aux relay.	1. Aux relay stuck closed. 2. Aux relay shorted.
5,1	KEY SWITCH SRO	SRO fault.	1. Keyswitch not off at power-up. 2. Keyswitch shorted.
5,2	MAIN COIL OPEN	Missing main contactor.	1. Main contactor coil open or not connected.
5,3	AUX DRIVER ON	Aux (EM brake or WalkAway™ relay) driver coil held low.	1. Aux output short to ground. 2. Controller defective.
5,5	MAIN DROPOUT	Main contactor open.	1. Main contactor defective.

**LED DIAGNOSTICS**

A built-in Status LED is visible through a window in the label on top of the controller. When the controller detects a fault, the Status LED flashes the 2-digit fault code. The code is flashed continuously until the fault is corrected. For example, code “3,2”—welded main contactor—appears as:

□ □ □ □ □	□ □ □ □ □	□ □ □ □ □	etc.
( 3 , 2 )	( 3 , 2 )	( 3 , 2 )	

The codes are listed in the Troubleshooting Chart. Only one fault is indicated at a time, and faults are not queued up. If multiple faults are active simultaneously, the code of the highest priority fault is flashed. After all faults have been cleared, the code of the last active fault will continue to flash for one minute. This feature is designed to help service personnel identify intermittent faults when no programmer is available.

# 7

## MAINTENANCE

There are no user serviceable parts in the Curtis 1266 controller. **No attempt should be made to open, repair, or otherwise modify the controller.** Doing so may damage the controller and will void the warranty.

It is recommended that the controller be kept **clean and dry** that its diagnostics history file be checked and cleared periodically.

### CLEANING

Periodically cleaning the controller exterior will help protect it against corrosion and possible electrical control problems created by dirt, grime, and chemicals that are part of the operating environment and that normally exist in battery powered systems. **When working around any battery powered vehicle, proper safety precautions should be taken.** These include, but are not limited to: proper training, wearing eye protection, and avoiding loose clothing and jewelry.



Use the following cleaning procedure for routine maintenance. Never use a high pressure washer to clean the controller.

1. Remove power by disconnecting the battery.
2. Discharge the capacitors in the controller by connecting a load (such as a contactor coil or a horn) across the controller's B+ and B- terminals.
3. Remove any dirt or corrosion from the power and signal connector areas. The controller should be wiped clean with a moist rag. Dry it before reconnecting the battery.
4. Make sure the connections are tight. Refer to Section 2, page 7, for maximum tightening torque specifications for the battery and motor connections.

### FAULT HISTORY

The programmer's Fault menu can be used to access the controller's fault history file. The programmer will read out all the faults that the controller has experienced since the last time the fault history file was cleared. The faults may be intermittent faults, faults caused by loose wires, or faults caused by operator errors. Faults such as contactor faults may be the result of loose wires; contactor wiring should be carefully checked. Faults such as HPD or overtemperature may be caused by operator habits or by overloading.

After a problem has been diagnosed and corrected, it is a good idea to clear the fault history file. This allows the controller to accumulate a new file of faults. By checking the new fault history file at a later date, you can readily determine whether the problem was indeed fixed.



## **APPENDIX A**

### **VEHICLE DESIGN CONSIDERATIONS REGARDING ELECTROMAGNETIC COMPATIBILITY (EMC) AND ELECTROSTATIC DISCHARGE (ESD)**

#### **ELECTROMAGNETIC COMPATIBILITY (EMC)**

Electromagnetic compatibility (EMC) encompasses two areas: emissions and immunity. *Emissions* are radio frequency (RF) energy generated by a product. This energy has the potential to interfere with communications systems such as radio, television, cellular phones, dispatching, aircraft, etc. *Immunity* is the ability of a product to operate normally in the presence of RF energy.

EMC is ultimately a system design issue. Part of the EMC performance is designed into or inherent in each component; another part is designed into or inherent in end product characteristics such as shielding, wiring, and layout; and, finally, a portion is a function of the interactions between all these parts. The design techniques presented below can enhance EMC performance in products that use Curtis motor controllers.

##### *Emissions*

Signals with high frequency content can produce significant emissions if connected to a large enough radiating area (created by long wires spaced far apart). Contactor drivers and the motor drive output from Curtis controllers can contribute to RF emissions. Both types of output are pulse width modulated square waves with fast rise and fall times that are rich in harmonics. (Note: contactor drivers that are not modulated will not contribute to emissions.) The impact of these switching waveforms can be minimized by making the wires from the controller to the contactor or motor as short as possible and by placing the wires near each other (bundle contactor wires with Coil Return; bundle motor wires separately).

For applications requiring very low emissions, the solution may involve enclosing the controller, interconnect wires, contactors, and motor together in one shielded box. Emissions can also couple to battery supply leads and throttle circuit wires outside the box, so ferrite beads near the controller may also be required on these unshielded wires in some applications. It is best to keep the noisy signals as far as possible from sensitive wires.

##### *Immunity*

Immunity to radiated electric fields can be improved either by reducing overall circuit sensitivity or by keeping undesired signals away from this circuitry. The controller circuitry itself cannot be made less sensitive, since it must accurately detect and process low level signals from sensors such as the throttle potentiometer. Thus immunity is generally achieved by preventing the external RF energy from coupling into sensitive circuitry. This RF energy can get into the controller circuitry via conducted paths and radiated paths.

Conducted paths are created by the wires connected to the controller. These wires act as antennas and the amount of RF energy coupled into them is generally proportional to their length. The RF voltages and currents induced in each wire are applied to the controller pin to which the wire is connected. Curtis controllers include bypass capacitors on the printed circuit board's throttle wires to reduce the impact of this RF energy on the internal circuitry. In some applications, additional filtering in the form of ferrite beads may also be required on various wires to achieve desired performance levels.

Radiated paths are created when the controller circuitry is immersed in an external field. This coupling can be reduced by placing the controller as far as possible from the noise source or by enclosing the controller in a metal box. Some Curtis controllers are enclosed by a heatsink that also provides shielding around the controller circuitry, while others are partially shielded or unshielded. In some applications, the vehicle designer will need to mount the controller within a shielded box on the end product. The box can be constructed of just about any metal, although steel and aluminum are most commonly used.

Most coated plastics do not provide good shielding because the coatings are not true metals, but rather a mixture of small metal particles in a non-conductive binder. These relatively isolated particles may appear to be good based on a dc resistance measurement but do not provide adequate electron mobility to yield good shielding effectiveness. Electroless plating of plastic will yield a true metal and can thus be effective as an RF shield, but it is usually more expensive than the coatings.

A contiguous metal enclosure without any holes or seams, known as a Faraday cage, provides the best shielding for the given material and frequency. When a hole or holes are added, RF currents flowing on the outside surface of the shield must take a longer path to get around the hole than if the surface was contiguous. As more "bending" is required of these currents, more energy is coupled to the inside surface, and thus the shielding effectiveness is reduced. The reduction in shielding is a function of the longest linear dimension of a hole rather than the area. This concept is often applied where ventilation is necessary, in which case many small holes are preferable to a few larger ones.

Applying this same concept to seams or joints between adjacent pieces or segments of a shielded enclosure, it is important to minimize the open length of these seams. Seam length is the distance between points where good ohmic contact is made. This contact can be provided by solder, welds, or pressure contact. If pressure contact is used, attention must be paid to the corrosion characteristics of the shield material and any corrosion-resistant processes applied to the base material. If the ohmic contact itself is not continuous, the shielding effectiveness can be maximized by making the joints between adjacent pieces overlapping rather than abutted.

The shielding effectiveness of an enclosure is further reduced when a wire passes through a hole in the enclosure; RF energy on the wire from an external field is re-radiated into the interior of the enclosure. This coupling mechanism can be reduced by filtering the wire where it passes through the shield boundary.

Given the safety considerations involved in connecting electrical components to the chassis or frame in battery powered vehicles, such filtering will usually consist of a series inductor (or ferrite bead) rather than a shunt capacitor. If a capacitor is used, it must have a voltage rating and leakage characteristics that will allow the end product to meet applicable safety regulations.

The B+ (and B-, if applicable) wires that supply power to control panels—such as an electronic throttle, or control wires such as keyswitch, direction, etc.—should be bundled with the other control wires to the panel so that all these wires are routed together. If the wires to the control panel are routed separately, a larger loop area is formed. Larger loop areas produce more efficient antennas which will result in decreased immunity performance.

Keep all low power I/O separate from the motor and battery leads. When this is not possible, cross them at right angles.

## **ELECTROSTATIC DISCHARGE (ESD)**

Curtis PMC motor controllers contain ESD-sensitive components, and it is therefore necessary to protect them from ESD (electrostatic discharge) damage. Most of these control lines have protection for moderate ESD events, but must be protected from damage if higher levels exist in a particular application.

ESD immunity is achieved either by providing sufficient distance between conductors and the ESD source so that a discharge will not occur, or by providing an intentional path for the discharge current such that the circuit is isolated from the electric and magnetic fields produced by the discharge. In general the guidelines presented above for increasing radiated immunity will also provide increased ESD immunity.

It is usually easier to prevent the discharge from occurring than to divert the current path. A fundamental technique for ESD prevention is to provide adequately thick insulation between all metal conductors and the outside environment so that the voltage gradient does not exceed the threshold required for a discharge to occur. If the current diversion approach is used, all exposed metal components must be grounded. The shielded enclosure, if properly grounded, can be used to divert the discharge current; it should be noted that the location of holes and seams can have a significant impact on ESD suppression. If the enclosure is not grounded, the path of the discharge current becomes more complex and less predictable, especially if holes and seams are involved. Some experimentation may be required to optimize the selection and placement of holes, wires, and grounding paths. Careful attention must be paid to the control panel design so that it can tolerate a static discharge.

MOV, transorbs, or other devices can be placed between B- and offending wires, plates, and touch points if ESD shock cannot be otherwise avoided.

## APPENDIX B PROGRAMMERS

Curtis programmers provide programming, diagnostic, and test capabilities for the 1266 controller. The power for operating the programmer is supplied by the host controller via a 4-pin connector. Two programmers are available: the PC Programming Station (1314) and the handheld programmer (1311). The Programming Station has features not available on the handheld unit; on the other hand, the handheld programmer has the advantage of being more portable. Typically the Programming Station is used to set up the parameters initially and the handheld programmer is used to make adjustments in the field.

Two versions of each programmer are available: the User programmers can adjust only User-access parameters, whereas the OEM programmers can adjust all the parameters.

### HANDHELD PROGRAMMER (1311)

The 1311 programmer is easy to use, with self-explanatory functions. After plugging in the programmer, wait a few seconds for it to boot up and gather

**Fig. B-1** *Curtis 1311 handheld programmer.*

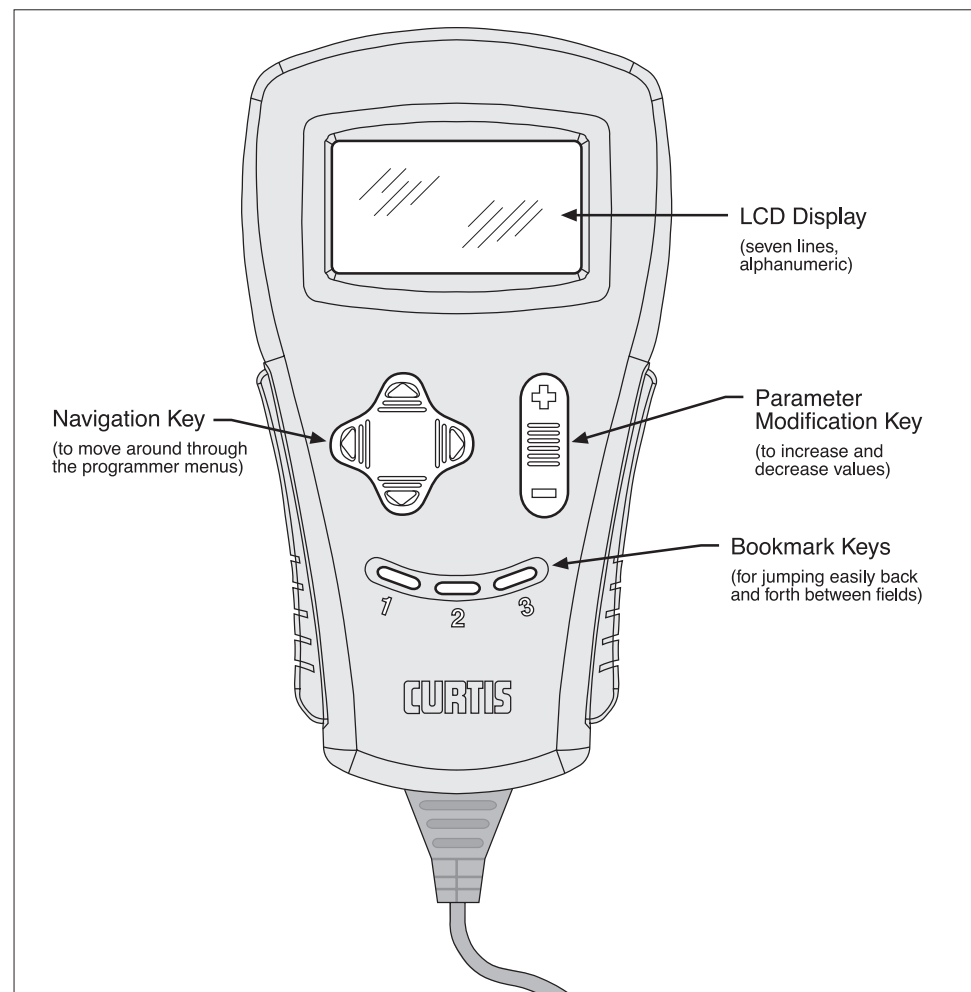

information from the controller. For experimenting with settings, the programmer can be left plugged in while the vehicle is driven.

The bookmark keys can make parameter adjustment more convenient. For example, in setting the throttle parameters, you might set a bookmark at the first of these parameters [Program » Throttle 100%] and another at the raw throttle readout [Monitor » Throttle]; this way you can easily toggle between the readout and the parameter.

To set a bookmark, press one of the three bookmark keys for more than two seconds. To jump to a bookmarked location, press the appropriate bookmark key quickly (for less than two seconds).

The bookmark keys also have another function that makes programming easier. When setting the value of a parameter, you can use these keys to adjust the increments by which the value changes—with Bookmark Key 1, the value changes in 10-digit steps up or down; with Bookmark Key 2 pressed, the value changes in 100-digit steps; and with Bookmark Key 3, in 1000-digit steps—which, for most parameters, takes you from the maximum to the minimum, or vice versa.

## **PC PROGRAMMING STATION (1314)**

The Programming Station is an MS-Windows 32-bit application that runs on a standard Windows PC. It can do everything the handheld programmer can do, and more. Its additional capabilities include saving/restoring sets of parameters to/from disk and updating software. Instructions for using the Programming Station are included with the software.

## **PROGRAMMER MENUS**

The programmers have six menus:

Program — provides access to the individual programmable parameters.

Monitor — presents real-time values during vehicle operation; these include all inputs and outputs.

Faults — presents diagnostic information, and also a means to clear the fault history file.

Functions — provides access to the controller-cloning commands and to the “reset” command.

Information — displays data about the host controller: model and serial numbers, date of manufacture, hardware and software revisions, and itemization of other devices that may be associated with the controller’s operation.

Programmer Setup — displays data about the programmer: model and serial numbers, and date of manufacture.

The Program Menu and Monitor Menu are presented here. For Faults, see the Troubleshooting Chart in Section 6. The other three menus are self-explanatory.

### Program Menu *(not all items available on all controllers)*

Parameters are listed here in the order in which they appear in the Program Menu displayed by the programmer.

M1 MAIN C/L	Drive current limit in Mode 1.
M2 MAIN C/L	Drive current limit in Mode 2.
REGEN C/L	Current limit during regen braking.
PLUG C/L	Current limit during plug braking.
AUX DRVR MODE	0=none, 1=WalkAway™, 2=EM brake.
AUX PULL IN	Voltage at aux driver (pin 23) during first 0.1 second.
AUX HOLDING	Voltage at aux driver (pin 23) after first 0.1 second.
EMB DELAY	Delay before EM brake is applied.
FLD BRAKE	Enable field braking, to slow vehicle near zero speed.
FLD BRAKE SPD	Speed threshold below which field braking occurs.
FLD BRAKE MAX	Max field current allowed during field braking.
FLD BRAKE RATE	Sets how quickly field current rises during field braking.
EMB SPD CHECK	Enable controller to attempt to stop vehicle before locking EMB after main contactor fault.
EMB SPD VALUE	Threshold speed at which EMB is allowed to lock during a main contactor fault.
RPM TO SPEED	Conversion factor for motor to vehicle speed.
TACHO POLES	Number of poles in speed sensor magnet.
MODE AFTER KEY	Mode change allowed after KSI activated (yes/no).
WARNING OPTION	Sets conditions for warning signals.
M1 FWD SPEED	Maximum forward speed in Mode 1.
M1 ACCEL	Forward acceleration rate in Mode 1.
M1 DECEL	Forward deceleration rate in Mode 1.
M1 BRAKE MIN	% of Main C/L at start of brake map, Mode 1.
M1 BRAKE MAX	% of Main C/L at end of brake map, Mode 1.
M1 BRAKE MAP	% of Main C/L at midpoint of brake map, Mode 1.
M1 BRAKE START	Vehicle speed at start of brake map, Mode 1.
M1 BRAKE END	Vehicle speed at end of brake map, Mode 1.
REV SPEED	Maximum reverse speed.
REV ACCEL	Reverse acceleration rate.
REV DECEL	Reverse deceleration rate.
REV BRAKE MIN	% of Main C/L at start of reverse brake map.
REV BRAKE MAX	% of Main C/L at end of reverse brake map.

**Program Menu, cont'd**

REV BRAKE MAP	% of Main C/L at midpoint of reverse brake map.
REV BRK START	Vehicle speed at start of reverse brake map.
REV BRAKE END	Vehicle speed at end of reverse brake map.
M2 FWD SPEED	Maximum forward speed in Mode 2.
M2 ACCEL	Forward acceleration rate in Mode 2.
M2 DECEL	Forward deceleration rate in Mode 2.
M2 BRAKE MIN	% of Main C/L at start of brake map, Mode 2.
M2 BRAKE MAX	% of Main C/L at end of brake map, Mode 2.
M2 BRAKE MAP	% of Main C/L at midpoint of brake map, Mode 2.
M2 BRAKE START	Vehicle speed at start of brake map, Mode 2.
M2 BRAKE END	Vehicle speed at end of brake map, Mode 2.
OVERVOLTAGE	Threshold above which regen current decreases.
LOW VOLTAGE	Threshold below which drive current decreases.
THROTTLE MAP	Midpoint value that shapes the throttle map.
THROTTLE 0%	Voltage at which throttle command begins.
THROTTLE 100%	Voltage at which throttle command is maxed out.
THROT FAULT LO	Voltage under which a throttle fault occurs.
THROT FAULT HI	Voltage over which a throttle fault occurs.
M1 FWD FLD MIN	Minimum field current, forward direction, Mode 1.
REV FIELD MIN	Minimum field current, reverse direction.
M2 FWD FLD MIN	Minimum field current, forward direction, Mode 1.
FLD MAP START	Positive armature current at which field map begins.
FIELD RAMP	Midpoint value that shapes the field map.
FIELD MAX	Maximum field current during drive.
FIELD MAP END	Positive armature current at which field map ends.
NEG FLD MAP ST	Neg. armature current at which neg. field map begins.
NEG FIELD RAMP	Midpoint value that shapes the negative field map.
NEG FIELD MAX	Maximum field current during regen braking.
NEG FLD MAP EN	Neg. armature current at which neg. field map ends.
WALKAWAY C/L	Field current during WalkAway™ operation.
KSI SRO ENABLE	Keyswitch must be off at power-up (yes/no).

## Monitor Menu

Items are listed here in the order in which they appear in the Monitor Menu displayed by the programmer.

SPEED INPUT	Speed reading.
THROTTLE	Throttle reading, as % of full throttle.
BATTERY VOLTS	Voltage at Logic Power (pin 16).
HEATSINK TEMP	Heatsink temperature, in °C.
MODE	Controller operating mode: Mode 1 or Mode 2.
ARM CURRENT	Motor armature current, in amps.
FIELD CURRENT	Motor field current, in amps.
ARM PWM	Motor armature applied duty cycle, as %.
FIELD PWM	Motor field applied duty cycle, as %.
FOOT INPUT	Pedal interlock switch: on/off.
KEY INPUT	Keyswitch: on/off.
FORWARD INPUT	Forward switch: on/off.
REVERSE INPUT	Reverse switch: on/off.
MODE SWITCH	Mode switch: on/off.
AUX CONTACTOR	WalkAway™ relay or EM brake at pin 23: on/off.
MAIN DRIVER	Main contactor driver: high/low.

## APPENDIX C

### PROGRAMMABLE PARAMETER INDEX

The 1266 controller's programmable parameters are listed below in alphabetical order (by programmer display name), with references provided to the parameter descriptions and to the appropriate Tuning Guide procedures.

The parameters are described individually in Section 3. It is important also to read the tuning procedures in Section 5, as many parameters are highly interdependent with other parameters.

Note: The bulleted parameters (•) are not included in the Tuning Guide; the information provided in Section 3 is sufficient for adjusting these parameters.

	Sec. 3	Sec. 5		Sec. 3	Sec. 5
ACCEL, M1-M2-REV	p. 17	⑥, p. 39	•KSI SRO ENABLE	p. 26	
•AUX DRVR MODE	p. 28		•LOW VOLTAGE	p. 26	
•AUX PULL IN	p. 28		MAIN C/L, M1-M2	p. 21	③, p. 34
•AUX HOLDING	p. 28		•MODE AFTER KEY	p. 26	
BRAKE END, M1-M2-REV	p. 22	⑦, p. 40	NEG FIELD MAX	p. 24	⑤, p. 38
BRAKE MAX, M1-M2-REV	p. 22	⑦, p. 40	NEG FIELD RAMP	p. 25	⑤, p. 38
BRAKE MAP, M1-M2-REV	p. 23	⑦, p. 40	NEG FLD MAP EN	p. 25	⑤, p. 38
BRAKE MIN, M1-M2-REV	p. 22	⑦, p. 40	NEG FLD MAP ST	p. 24	⑤, p. 38
BRAKE START, M1-M2-REV	p. 22	⑦, p. 40	•OVERVOLTAGE	p. 26	
DECEL, M1-M2-REV	p. 17	⑦, p. 40	PLUG C/L	p. 21	⑩, p. 43
EMB DELAY	p. 29	⑩, p. 44	REGEN C/L	p. 21	⑤, p. 38
•EMB SPD CHECK	p. 29		REV FIELD MIN	p. 24	④, p. 37
•EMB SPD VALUE	p. 29		REV SPEED	p. 19	②, p. 34
FIELD MAP END	p. 25	③, p. 34	RPM TO SPEED	p. 19	②, p. 34
FIELD MAX	p. 24	③, p. 34	TACHO POLES	p. 19	②, p. 34
FIELD RAMP	p. 25	④, p. 37	THROT FAULT LO	p. 21	①, p. 32
FLD BRAKE	p. 17	⑪, p. 43	THROT FAULT HI	p. 21	①, p. 32
FLD BRAKE MAX	p. 18	⑪, p. 43	THROTTLE 0%	p. 20	①, p. 32
FLD BRAKE RATE	p. 18	⑪, p. 43	THROTTLE 100%	p. 20	①, p. 32
FLD BRAKE SPD	p. 17	⑪, p. 43	THROTTLE MAP	p. 20	①, p. 32
FLD MAP START	p. 24	④, p. 37	WALKAWAY C/L	p. 21	⑩, p. 43
FWD FLD MIN, M1-M2	p. 24	④, p. 37	•WARNING OPTION	p. 26	
FWD SPEED, M1-M2	p. 19	②, p. 34			

## APPENDIX D SPECIFICATIONS

### SPECIFICATIONS: 1266 CONTROLLER

Nominal input voltage	36V or 48V
PWM operating frequency	16 kHz
Electrical isolation to heatsink	500 V ac (minimum)
Logic enable and logic power input voltage (minimum)	16.8 V
Logic enable and logic power input current (no contactors engaged)	160 mA without programmer; 200 mA with programmer
Logic input voltage	>20.0 V High; <7.5 V Low
Logic input current	10 mA
Operating ambient temperature range	-40°C to 50°C (-40°F to 122°F)
Heatsink overtemperature cutback	starts at 85°C (185°F); cutoff at 95°C (203°F)
Heatsink undertemperature cutback	50% armature current at -25°C (-13°F)
Package environmental rating	IP5X
Weight	3.9 kg (8.5 lb)
Dimensions (LxWxH)	229 × 178 × 81 mm (9.0" × 7.0" × 3.2")

MODEL NUMBER	NOMINAL BATTERY VOLTAGE (volts)	ARMATURE 2 MIN RATING (amps)	FIELD 2 MIN RATING (amps)
1266-52XX	36-48	275	20