



SEM
Including MicropaK.

This user manual details the features of the following MicropaK and PowerpaK SEM (Separately Excited Motor) Traction controllers and variants.

- | | | | |
|----|-------------------------|---------------------|----------------------------------|
| 1. | PowerpaK SEM | 24-48V 350A/50A | SEM Low I/O Logic |
| 2. | PowerpaK SEM | 24-48V 500A/50A | SEM Low I/O Logic |
| 3. | PowerpaK SEM | 72-80V 425A/50A | SEM Low I/O Logic |
| 4. | MicropaK SEM | 24-36V 200A/30A | Combined Power and Low I/O Logic |
| 5. | MicropaK SEM | 36-48V 270A/30A | Combined Power and Low I/O Logic |
| 6. | PowerpaK SEM Dual Motor | 2 x 24-48V 350A/50A | SEM Low I/O Logic + CAN Slave |
| 7. | PowerpaK SEM Dual Motor | 2 x 24-48V 500A/50A | SEM Low I/O Logic + CAN Slave |

Modification History

Revision	Issue Date	Author	Changes
Rev E	17 May 1999	R.T.	Fuse Rating & minor changes
Rev F	24 November 1999	C.E.H.	New Personalities & Speed Control
Rev G	13 January 2000	S.L.	Amended specification of 80V PowerpaK
Rev H	5 April 2000	A.J.K.	Add 48V MicropaK & amend Personalities
Rev J	5 September 2000	A.J.K.	New Personalities Added (applicable to V1.06E and V1.50 software)
Rev K	5 September 2001	JRM	Power wiring drawing updated
Rev L	18 February, 2002	PR / CH	Reviewed and ammended Personalities
Rev M	1 March, 2002	CH	Updated I/O Configuration Tables

CONTENTS

MODIFICATION HISTORY	1
1 INTRODUCTION	3
2 SEM CONTROLLER VARIANTS	4
3 CONTROLLER FEATURES	5
4 SAFETY	6
5 TECHNICAL SPECIFICATIONS	7
6 CONTROLLER WIRING AND CONNECTIONS	9
7 CALIBRATOR AND ADJUSTMENTS	12
8 DIAGNOSTICS	21
9 SERVICE AND FAULT LOGS	22
10 CONTROLLER OPERATION AND FEATURE DESCRIPTIONS	23
11 DASHBOARD DISPLAYS - OPERATION AND FEATURE DESCRIPTIONS	30
12 CONTROLLER OPERATION AND POWER CIRCUIT DESCRIPTIONS	37
13 INSTALLATION	42
14 EMC GUIDELINES	43
FIGURE 1 LIGHT WIRING - MICROPAK	47
FIGURE 2 POWER WIRING - MICROPAK	47
FIGURE 3 LIGHT WIRING - POWERPAK	48
FIGURE 4 POWER WIRING – POWERPAK	48
FIGURE 5 POWERPAK SEM DUAL MOTOR - CAN MASTER / SLAVE ARRANGEMENT	49
FIGURE 6 MECHANICAL DETAILS - POWERPAK	50
FIGURE 7 MECHANICAL DETAILS - MICROPAK	51

1 INTRODUCTION

The MicropaK & PowerpaK SEM (Separately Excited Motor) range of Controllers uses a new concept in power switching technology to provide a full range of power frames 24V-80V, 200A-500A in one small, highly efficient package. This is achieved using a new power switching scheme and radical new construction techniques, both the subject of patent applications, which enable large powers to be incorporated into very small packages.

The MicropaK is a standalone Traction SEM controller mainly aimed at the walkie market, whilst the PowerpaK SEM is a larger power controller suitable for a range of ride-on trucks. The MicropaK has an integrated logic, whilst the PowerpaK, to improve flexibility and serviceability, has a logic that is plugged into the power frame and can be removed easily without disturbing power connections or having to remove the power frame cover.

Both controllers have serial communication abilities, CAN and RS232 with an additional module. Multi controller systems such as Dual Traction motor SEM or Traction + Pump systems use CAN communications in a master / slave(s) environment.

Controllers are microprocessor based with flexible software and setup options, and use high frequency (silent) MOSFET power switching technology, to control a SEM power frame comprising of an independently controlled half bridge Armature circuit and an independently controlled full bridge Field circuit. Armature and Field currents are both measured with a shunt system. Motor feedback should not be necessary although there is provision to interface to either a motor tacho or encoder if necessary. Controllers have been designed to satisfy the requirements of the relevant UL and EC standards.



MicropaK



PowerpaK

2 SEM CONTROLLER VARIANTS

PPxxx		Model number description	
	1st digit	Controller Type	1 = ----- 2 = --Reserved-- (Series Traction Standalone) 3 = --Reserved-- (Series Pump Standalone) 4 = ----- 5 = --Reserved-- (Series Traction Dual Motor Proportional) 6 = --Reserved-- (Series Traction Dual Motor Non Proportional) 7 = SEM Standalone Traction 8 = -----
	2nd digit	Voltage Range	2 = 24V - 36V 4 = 24V - 48V 8 = 72V - 80V
	-3rd digit	Current Limit	1 = 200A/30A Armature/Field 2 = 270A/30A 3 = 350A/50A 4 = 425A/50A 5 = 500A/50A
		Prefix	PP = PowerpaK variant MP = MicropaK variant

MODEL	POWER	CONFIGURATION	LOGIC	NO. off Power Terminals	UNIT SIZE
MP722	24-36V 270A/30A	Traction SEM	Integrated	5	152 x 152 x 69mm
MP742	36-48V 270A/30A	Traction SEM	Integrated	5	152 x 152 x 69mm
PP743	24-48V 350A/50A	Traction SEM	Low I/O	6	142 x 142 x 140mm
PP745	24-48V 500A/50A	Traction SEM	Low I/O	6	142 x 142 x 140mm
PP784	72-80V 425A/50A	Traction SEM	Low I/O	6	142 x 142 x 140mm
PP743 +	24-48V 350A/50A +	Traction SEM (Master) +	Low I/O +	6 +	142 x 142 x 140mm +
PP743	24-48V 350A/50A	Traction SEM (Slave)	Slave I/O	6	142 x 142 x 140mm
PP745 +	24-48V 500A/50A +	Traction SEM (Master) +	Low I/O +	6 +	142 x 142 x 140mm +
PP745	24-48V 500A/50A	Traction SEM (Slave)	Slave I/O	6	142 x 142 x 140mm

3 CONTROLLER FEATURES

Logic Feature	MicropaK	PowerpaK
Logic	Combined	Separate
Number of Connectors	2	2
Number of Digital switch inputs.	6	6
Number of Analogue inputs	2	2
Number of Contactor drive outputs	2	2
Voltage Operation range	24-48V	24-80V
Armature Current Limit range	200-270A	350-500A
Field Current Limit range	20-30A	30-50A
Armature and Field currents independently measured	yes	yes
Solid state direction control	yes	yes
Good speed regulation without speed sensor	yes	yes
Motor curve setup menu	yes	yes
Armature to Field current mapping adjustment	yes	yes
Case enclosed to IP66	yes	yes
Microprocessor control	yes	yes
High frequency (Silent Operation) Armature + Field	yes	yes
Internal watchdog monitoring microprocessor operation	yes	yes
24Vcontactors at all voltages possible + built in suppression	yes	yes
Low impedance, active low inputs switched to B-ve	yes	yes
Thermally compensated current limit	yes	yes
Selectable accelerator characteristics	yes	yes
Adjustable creep speed	yes	yes
Variable Field Weakening without contactor	yes	yes
Seat switch timer	yes	yes
Belly switch operation	yes	yes
Line Contactor Drive	yes	yes
Power steer contactor driver and timer	yes	yes
Electric Brake driver for walkies	yes	yes
Regenerative braking down to zero speed	yes	yes
Braking proportional to accelerator position	yes	yes
Braking in neutral and with brake pedal	yes	yes
Under and Over-voltage protection	yes	yes
Accelerator wire off detect	yes	yes
Inching and timed burst inching facilities	yes	yes
Economy pot input	yes	yes
2 traction cutback speeds with independent accel delays	yes	yes
Hardware and Software fail-safe systems	yes	yes
+ 12V output pin	yes	yes
Diagnostics with LED indication	yes	yes
Adjustments made via a calibrator	yes	yes
Serial communications (external module gives RS232)	yes	yes
Can be setup with a PC (via above external module)	yes	yes
CAN serial communications	yes	yes
Hours count displaying Key & Pulsing hours on calibrator	yes	yes
BDI on Calibrator	yes	yes
Dual Motor Proportional variant with switches or pot	yes	yes
Dual Motor steer angles can be adjusted	yes	yes
Sensorless Speed Control	yes	yes
Resettable Service and Fault logs	yes	yes
Foreign languages selectable on calibrator	yes	yes
Standard + Full Feature Dashboard Display compatible	yes	yes
Setup menu on calibrator to enable various options	yes	yes
Additional Suppression for 2 External Contactors	yes	no

4 SAFETY

- 4.1 Electric vehicles can be dangerous. All testing, fault-finding and adjustment should be carried out by competent personnel. The drive wheels should be off the floor and free to rotate during the following procedures. THE VEHICLE MANUFACTURER'S MANUAL SHOULD BE CONSULTED BEFORE ANY OPERATION IS ATTEMPTED.
- 4.2 The SEM controller contains a triple fail-safe system to give a high level of safety. If the diagnostic LED is not illuminated or flashes, the safety circuit may have tripped and the truck may not drive.
- 4.3 To ensure continued safety of the SEM system, the fail-safe circuit should be checked whenever the truck is serviced . The period between checks should not exceed 3 months.
- 4.4 THE BATTERY MUST BE DISCONNECTED BEFORE REPLACING OR ATTEMPTING ANY REPAIRS OF THE CONTROLS.
- 4.5 Before working on the controls disconnect the battery and connect the B+ and B- controller terminals via a 10 ohm 25 watt resistor to discharge the internal capacitors.
- 4.6 Never connect the controller to a battery with its vent caps removed as an arc may occur due to the controller's internal capacitance when it is first connected.
- 4.7 The controller must be used with a line contactor as indicated in the wiring diagrams.
- 4.8 As blow-out magnets are fitted to contactors (except 24V) ensure that no magnetic particles can accumulate in the contact gaps and cause malfunction. Ensure that contactors are wired with the correct polarity to their power terminals as indicated by the + sign on the top moulding.
- 4.9 The controller must NOT be used with permanently-connected on-board chargers or damage to the system may result.

5 TECHNICAL SPECIFICATIONS

5.1 Electrical

5.1.1 Voltage specifications:

Model	Voltage	Nominal Battery	Absolute Maximum Operating voltage
MPx2x	24V Units	24-36V	14.5 - 50V
MPx4x	48V Units	36-48V	30.0 – 75V
PPx4x	48V Units	24-48V	14.5 - 75V
PPx8x	80V Units	72-80V	43.0-100V

5.1.2

Current specifications:

Model	Power	Current limit Armature (1 min)	Current limit Field (1 min)	Safe operating Area (SOA)	Continuous Current 1 Hour rating. **
MPx22	24V 270A	270A	30A	30 – 60%	100A
MPx42	48V 270A	270A	30A	30 – 60%	100A
PPx43	48V 350A	350A	50A	30 – 60%	117A
PPx45	48V 500A	500A	50A	30 – 60%	167A
PPx85	80V 425A	425A	50A	30 – 60%	167A

**** Unit mounted on an aluminium base-plate 780x380x10mm, at 20°C ambient. Refer to Section 12 for installation guidelines.**

5.1.3 Switching Frequency:

16 KHz Traction drive Armature+Field/Regen Braking.

5.1.4 Electrical Isolation:

Enclosure to any live part = 1KV. Controller internal insulation specified at > 10MΩ @500V DC. Dielectric strength 1000V @ 50Hz for 1 Minute.

5.1.5 Battery Polarity:

A Line Contactor driven from the Controller, with a 2A diode in series with the coil, will prevent Line Contactor closure if the battery positive and negative connections are reversed.

5.2 Environmental

5.2.1.1 Protection - MicropaK

The enclosure is protected to IP66.

1st digit (6) = Protection against dust ingress

2nd digit (6) = Protection against high pressure jets of water in any direction.

5.2.1.2 Protection - PowerpaK
Power Frame

The enclosure is protected to IP55.

1st digit (5) = Protection against objects > 1.0mm

Limited dust ingress permitted

2nd digit (5) = Protection against low pressure jets of water in any direction. Limited ingress permitted.

5.2.1.3 Protection - PowerpaK
Logic

The enclosure is protected to IP66.

(description as per 5.2.1.1 above)

5.2.2 Vibration:

6G, 40-200Hz for 1 hour, in x, y and z planes.

5.2.3 Operating Temperature:

-30°C to +40°C ambient around controller.

5.2.4 Storage Temperature:

-40°C to +70°C.

5.2.5 Humidity:

95% maximum, non-condensing.

5.2.6 Humidity Resistance:

No functional defects after controller is left at 60°C and 100% humidity for one hour after freezer use (-30°C minimum).

5.3 Mechanical

5.3.1.1 Unit size - Micropak

Length 152mm, Width 152mm, Height 69mm

5.3.1.2 Unit size - Powerpak

Length 142mm, Width 142mm, Height 140mm with logic fitted.
(Height is 86mm with logic unplugged)

5.3.2	Enclosure:	Aluminium die cast base-plate with ABS plastic injection moulded covers.
5.3.3 Power connections		
5.3.3.1	MicropaK	M6 for Armature connections, M6 for Field connections
5.3.3.2	PowerpaK	M8 for Armature connections, M8 for Field connections
5.3.4	Fixings:	4 x M6 clearance holes.
5.3.5 Weight		
5.3.5.1	MicropaK	1.5Kg
5.3.5.2	PowerpaK	1.8Kg
5.4 <u>Logic I/O Specifications</u>		
5.4.1	Switch/Digital Inputs:	
	Operation:	Active-low (The input becomes active when connected to battery negative, otherwise inactive).
	Voltage Range:	Low (Closed) -1.0 to +1.8 V High (Open) +4.5 to +150 V (or open-circuit).
	Input Impedance:	Max. resistance to ground for a 'low' = 500 Ω. Min. resistance to ground for a 'high' = 2.7 kΩ Note : negative switch returns must be connected to controller B- terminal and not at battery negative.
5.4.2	Analogue Inputs:	0-5V inputs available and 5K potentiometer/3V5-0V inputs available. Fully protected i/ps and threshold settable.
5.4.3	Supply output:	An unregulated +12V, 5mA power supply is available for supplying Accelerators, speed sensors etc.
5.4.4	Contacto Drives:	Maximum Current: 2A.
	Protection:	Drives are protected against direct connection to B+ and B-.
	Suppression:	Coil suppression built-in.
	+ve coil supply	Wire to key switch

6.1.1 Power Connections

See power wiring diagrams for specific connections.

6.1.2 Power wiring

Minimum cable sizes:-	Current limits up to	270A	25mm ²
		500A	35mm ²

6.1.3 Fuse ratings

Maximum fuse ratings:-	Current limits up to	180A	125A (air break)
		270A	175A (air break)
		350A	250A (air break)
		500A	325A (air break)

6.1.4 Contactor Types

The recommended contactors for controllers with current limits up to 270A are:

Line		Albright SW80	Continuous Rating
Power Steer	(Optional)	Albright SW80	Continuous Rating

The recommended contactors for controllers with current limits up to 500A are:

Line		Albright SW180	Continuous Rating
Power Steer	(Optional)	Albright SW80	Continuous Rating

It is recommended that 24 V contactors are used together with the chopping feature.

6.2 Light Wiring Connections (Fig. 1)

The following section details the connectors on the MicropaK and the PowerpaK SEM controllers. Both controllers have 2 connectors, 1 for the vehicle/contactor connections and 1 for serial communications.

6.2.1 Customer Connector Pin Outs

Pin No.	MICROPAK SEM Vehicle & Panel Connector Socket B 16 way Molex Connector. 6 Digital i/ps 2 Analog i/ps 2 Contactor Drives	POWERPAK SEM Vehicle & Panel Connector Socket B 12 way Molex Connector. 6 Digital i/ps 2 Analog i/ps 2 Contactor Drives
1.	Key sw	Key sw
2.	Fwd sw	Fwd sw
3.	Rev sw	Rev sw
4.	Belly/FS1 sw	FS1/Belly sw
5.	Tiller/Seat sw	Seat/Tiller sw
6.	Digital Pin 6 ¹	Digital Pin 6 ¹
7.	Digital Pin 7 ²	Digital Pin 7 ²
8.	Line Contactor o/p	Line Contactor o/p
9.	P.Steer / Pump / Brake / Remote LED o/p	P.Steer / Pump / Brake / Remote LED o/p
10.	Analogue i/p ³ 0V-10V	Analogue i/p ³ 0V-5V
11.	Analogue i/p ³ 3V5-0V	Analogue i/p ³ 3V5-0V
12.	+12V O/P	+12V O/P
13.	Additional Suppression Input	
14.	Additional Suppression Input	
15.	Not Used	
16.	Not Used	

Notes:

1. Digital Pin 6 = None / Speed 1 / Pump / Handbrake / P.Steer / Footbrake / Constant / Inch Fwd
2. Digital Pin 7 = None / Speed 2 / Pump / Handbrake / P.Steer / Override / Inch Rev
3. Analogue Pins 10 or 11 = None / Accelerator / Footbrake / Economy / Digital⁴
4. Analogue as Digital (Pin 10 or 11) = Speed 2 / Pump / Handbrake / P.Steer / Override / Speed 3

Pin No.	MICROPAK Communications Connector Socket A 6 way Molex Connector CAN (External module allows RS232 connection to PC)	POWERPAK Communications Connector Socket A 6 way Molex Connector CAN (External module allows RS232 connection to PC)
1.	+ 10V5	+ 10V5
2.	0V	0V
3.	N/C	N/C
4.	+ 10V5	+ 10V5
5.	CAN High	CAN High
6.	CAN Low	CAN Low

6.2.2 **Serial Communications Overview**

The PowerpaK and MicropaK have CAN communications as described below. A separate “dongle” CAN to RS232 (+/- 12V) module is available from SEVCON to allow connection of a PowerpaK(s) to a standard IBM compatible PC running Windows 95 onwards.

6.2.3 **CAN (Controller Area Network) Overview (PowerpaK and MicropaK)**

The main applications for CAN communications are automotive and industrial electronics where high speed, noise immune serial communications are required to work reliably in high vibration and high temperature environments.

SEVCON'S CAN system is defined as CAN 2.0B Passive and is implemented using a Siemens 80C515C Microprocessor and a Philips 80C250 transceiver chip. The PowerpaK /MicropaK CAN protocol sets the baud rate to be 100K bits per second.

CAN is extremely flexible and versatile, allowing multi-master operation in a serial communication network with an almost unlimited number of nodes. Data rates of up to 1 Mbit/s are possible transmitting over distances of up to 40 meters, with a very low probability of undetected errors. CAN is basically a 2-wire twisted-pair differential system with 10V5 and 0v supply rails. Connections are made via a 6way Molex.

The CAN bus is used to communicate with the calibrator, with a dashboard display, for remote control from a host PC (via external module) and other PowerpaK controllers on the vehicle. Long term, communications with other auxiliary equipment will be possible.

E.g. Battery Chargers, Standalone Power Steer Controllers, Joysticks ...etc. At present it is possible to connect up to 15 auxiliary pieces of equipment onto the CAN bus.

6.2.4 **Multi Controller Systems (e.g Traction + Pump or Dual Motor Traction + Pump)**

Vehicles that require 2 controllers or more, may communicate with each other over the CAN bus in a Master / Slave arrangement. This allows a single calibrator to be plugged in to adjust all controllers on the bus and for 1 display to be connected to the system.

Common multi controller systems include Traction + Pump systems (2 controllers) or Dual motor Traction systems (2 controllers) or Dual Motor Traction + Pump systems (3 controllers).

On a Traction + Pump system, an example of a communication between the two controllers, other than calibrator setup, would be the Traction unit receiving a power steer trigger input e.g FS1 and then informing the Pump to provide the power steer function. On a Dual Motor system an example would be a steering pot connected to the Master Traction unit on the right hand motor and the CAN bus being used to inform the Slave traction unit on the left hand motor to slow down during a turn.

7 CALIBRATOR AND ADJUSTMENTS

A sophisticated, yet easy to use hand held adjustment unit, called the Calibrator is used to make adjustments to the controller and select configurations. The Calibrator is also used as a diagnostic tool displaying the status of all voltages, currents and temperatures within the controller together with the condition of all the controller's switch and analogue inputs.

The diagram below describes how the Calibrator is used. The left and right arrows move between screens on the same level. The up and down arrows move between levels and the + and - buttons increment or decrement the parameters by the amount indicated in the STEP column of the following tables.

The calibrator can be specified to have various levels of access to certain adjustments. A multi-language version is available for newer controllers.

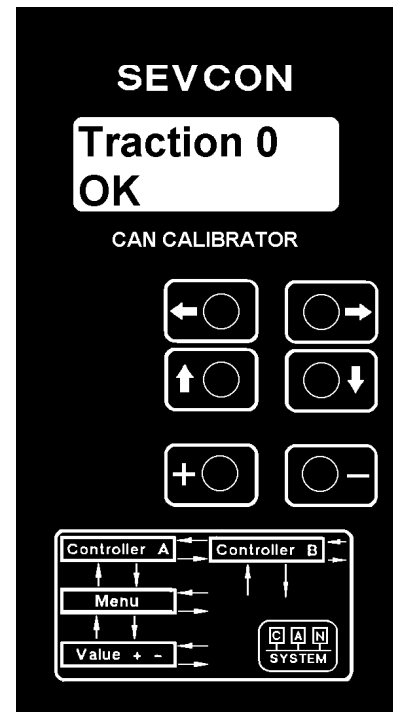

Calibrator Menu – Top Level

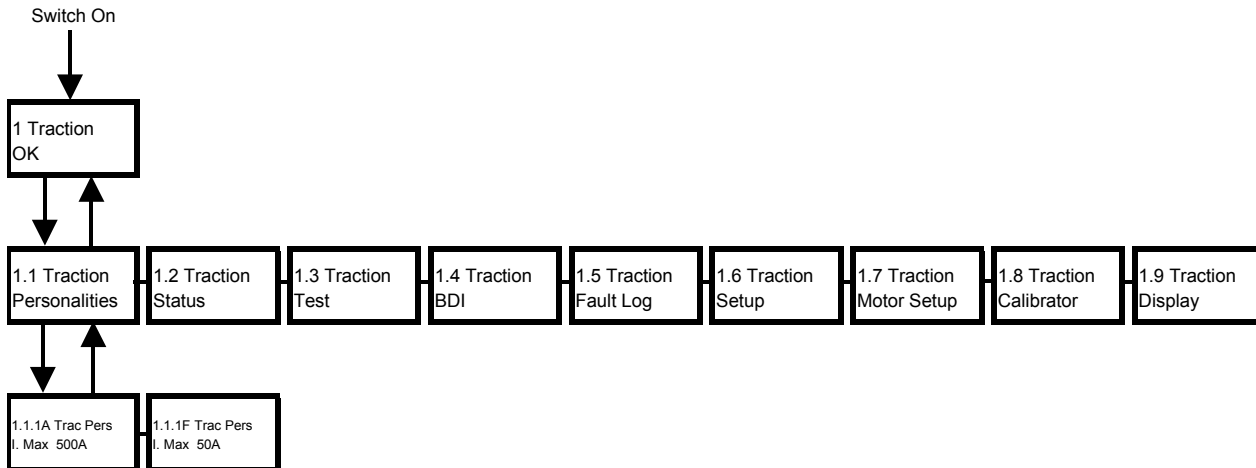

7.1.1 Traction Controller Personalities (Controller Adjustments)

Cal. Ref.	Parameter Adjusted	Min Adjust (All units)	Max. Adjust (200A unit)	Max. Adjust (270A unit)	Max. Adjust (350A unit)	Max. Adjust (500A unit)	Step Size all units	Typical Default
1.1.1A	Current limit Armature	50 A	200 A	270 A	350 A	500 A	10 A	100% A
1.1.1F	Current limit Field	10 A	30 A	30 A	50 A	50 A	1 A	100% A
1.1.2	Acceleration delay	0.1 S	5.0 S	5.0 S	5.0 S	5.0 S	0.1 S	1.5 S
1.1.3	Deceleration delay	0.1 S	0.5 S ²	0.5 S ²	0.5 S ²	0.5 S ²	0.1 S	0.3 S
1.1.4	Creep speed	0 %	25 %	25 %	25 %	25 %	1.0 %	5.0 %
1.1.5	Direction Regen Current ^a	50 A	200 A	270 A	350 A	500 A	10 A	180 A
1.1.5	Direction Regen Time ^a	0.1 S	5.0 S	5.0 S	5.0 S	5.0 S	0.1 S	1.5 S
1.1.6	Neutral Regen Current	10A (0 disables)	200 A	270 A	350 A	500 A	10 A	100 A
1.1.7	Footbrake Regen Current	10A (0 disables)	200 A	270 A	350 A	500 A	10 A	150 A
1.1.8	Regen Delay	0	300 ms	300 ms	300 ms	300 ms	10 ms	50 ms
1.1.9	Threshold Voltage	0.09 V	3.20 V	3.20 V	3.20 V	3.20 V	0.01 V	0.51 V
1.1.10	Maximum speed	0 %	100 %	100 %	100 %	100 %	1 %	100 %
1.1.11	Rolloff Field	1 % (0 disables)	100 %	100 %	100 %	100 %	1 %	100 %
1.1.12	Cutback speed 1	0 %	100 %	100 %	100 %	100 %	1 %	100 %
1.1.13	Acceleration delay 1	0.1 S	5.0 S	5.0 S	5.0 S	5.0 S	0.1S	0.1 S
1.1.14	Cutback speed 2	0 %	100 %	100 %	100 %	100 %	1 %	100 %
1.1.15	Acceleration delay 2	0.1 S	5.0 S	5.0 S	5.0 S	5.0 S	0.1 S	0.1 S
1.1.16	Cutback speed 3	0 %	100 %	100 %	100 %	100 %	1 %	100 %
1.1.17	Acceleration delay 3	0.1 S	5.0 S	5.0 S	5.0 S	5.0 S	0.1 S	0.1 S
1.1.18	Inch Speed	0 %	25 %	25 %	25 %	25 %	1 %	10 %
1.1.19	Burst Inch Delay	0.1 S	5.0 S	5.0 S	5.0 S	5.0 S	0.1 S	2.0 S
1.1.20	Power Steer Delay	0 S	60 S	60 S	60 S	60 S	1.0 S	5.0 S
1.1.21	Seat Switch Delay	0 S	5.0 S	5.0 S	5.0 S	5.0 S	0.1 S	2.0 S
1.1.22	Accelerator Zero Level	0.00 V	5.00 V ⁵	5.00 V ⁵	5.00 V ⁵	5.00 V ⁵	0.02 V ⁵	
1.1.23	Accelerator Full Level	0.00 V	5.00 V ⁵	5.00 V ⁵	5.00 V ⁵	5.00 V ⁵	0.02 V ⁵	
1.1.24	Footbrake Pot Zero Level	0.00 V	5.00 V ⁵	5.00 V ⁵	5.00 V ⁵	5.00 V ⁵	0.02 V ⁵	
1.1.25	Footbrake Pot Full Level	0.00 V	5.00 V ⁵	5.00 V ⁵	5.00 V ⁵	5.00 V ⁵	0.02 V ⁵	
1.1.26	Economy Pot Zero Level	0.00 V	5.00 V ⁵	5.00 V ⁵	5.00 V ⁵	5.00 V ⁵	0.02 V ⁵	
1.1.27	Economy Pot Full Level	0.00 V	5.00 V ⁵	5.00 V ⁵	5.00 V ⁵	5.00 V ⁵	0.02 V ⁵	
1.1.28	Steer Pot Left Level	0.00 V	5.00 V	5.00 V	5.00 V	5.00 V	0.02 V	
1.1.29	Steer Center	0.00 V	5.00 V	5.00 V	5.00 V	5.00 V	0.02 V	
1.1.30	Steer Pot Right Level	0.00 V	5.00 V	5.00 V	5.00 V	5.00 V	0.02 V	
1.1.31	Dual Motor Inner Angle	5 °	80 °	80 °	80 °	80 °	1.0 °	
1.1.32	Dual Motor Outer Angle	10°	85 °	85 °	85 °	85 °	1.0 °	
1.1.33	Constant Speed	4.0 KPH	6.0 KPH	6.0 KPH	6.0 KPH	6.0 KPH	0.2 KPH	5.6KPH
1.1.34	Belly Delay	0.5 S	5.0 S	5.0 S	5.0 S	5.0 S	0.1 S	1.5 S
1.1.35	Speed Limit	1.0 KPH	51.0 KPH	51.0 KPH	51.0 KPH	51.0 KPH	0.2 KPH	10.0 KPH
1.1.36	Speed Proportional	0 (0 disables)	128	128	128	128	1	20
1.1.37	Brake Proportional	0 (0 disables)	128	128	128	128	1	50
1.1.38	Speed Integral	0 (0 disables)	16	16	16	16	1	1
1.1.39	Brake Integral	0 (0 disables)	16	16	16	16	1	1

1.1.40	Low Voltage Init	14.5 V	36Von 24-36V units, 48Von 24-48V units, 80V on 72-80V units				0.5V	14.5 43V
1.1.41	Low Voltage Cutback	14.5 V	36Von 24-36V units, 48Von 24-48V units, 80V on 72-80V units				0.5V	14.5 43V
1.1.42	Protection Delay	0.1 S	2.5 S	2.5 S	2.5 S	2.5 S	0.1 S	0.5 S
1.1.43	High Voltage Init	14.5 V	50Von 24-36V units, 75Von 24-48V units, 100V on 72-80V units				0.5V	45 70 97.5V
1.1.44	High Voltage Cutback	14.5 V	50Von 24-36V units, 75Von 24-48V units, 100V on 72-80V units				0.5V	47.5 72.5 97.5V

Note 1: Depending on controller type and configuration some of the above may not be displayed.

Note 2: In Speed Control Mode, Deceleration Delay has a maximum of 5.0 S (all units).

Note 3: Direction Regen Current is displayed in Torque mode, and Direction Regen Time is displayed in Speed Control Mode.

Note 4: Pressing the calibrator “down arrow” key from the potentiometer zero and full personalities (1.1.22 to 1.1.29) jumps directly to the associated voltage measurement in the test menu. Pressing this key from the test menu jumps back to the associated zero level personality.

Note 5: If this analogue input is configured on pin 10 on the MicropaK unit, the maximum value is 10.00V and the step size is 0.04V.

7.1.2 Traction Controller Status Information

Cal. Ref.	Parameter Displayed	Min.Display	Max.Display	Step size	Log Info. ¹
1.2.1	Battery Voltage	0.0 V	127.5 V	0.5 V	+
1.2.2	Armature Motor Voltage	0.0 V	127.5 V	0.5 V	
1.2.2R	Armature Motor Voltage ²	0.0 V	127.5 V	0.5 V	
1.2.2L	Armature Motor Voltage ²	0.0 V	127.5 V	0.5 V	
1.2.3	Field Motor Voltage	0.0 V	127.5 V	0.5 V	
1.2.3R	Field Motor Voltage ²	0.0 V	127.5 V	0.5 V	
1.2.3L	Field Motor Voltage ²	0.0 V	127.5 V	0.5 V	
1.2.4	Armature Motor Current	0 A	625 A	5 A	+
1.2.4R	Armature Motor Current ²	0 A	625 A	5 A	
1.2.4L	Armature Motor Current ²	0 A	625 A	5 A	
1.2.5	Field Motor Current	0.00 A	32.00A(MP) 64.00A(PP)	0.25A	+
1.2.5R	Field Motor Current ²	0.00 A	32.00A(MP) 64.00A(PP)	0.25A	
1.2.5L	Field Motor Current ²	0.00 A	32.00A(MP) 64.00A(PP)	0.25A	
1.2.6	Armature MOSFET Voltage	0 V	127.5 V	0.5 V	
1.2.6R	Armature MOSFET Voltage ²	0 V	127.5 V	0.5 V	
1.2.6L	Armature MOSFET Voltage ²	0 V	127.5 V	0.5 V	
1.2.7	Capacitor Voltage	0 V	127.5 V	0.5 V	
1.2.8	Traction Controller Temp.	-30 °C	+225 °C	1 °C	+ -
1.2.8R	Traction Controller Temp ²	-30 °C	+225 °C	1 °C	
1.2.8L	Traction Controller Temp ²	-30 °C	+225 °C	1 °C	
1.2.9	Speed estimation (not sensor)	0.0 KPH	25.5 KPH	0.1 KPH	
1.2.9R	Speed estimation (not sensor) ²	0.0 KPH	25.5 KPH	0.1 KPH	
1.2.9L	Speed estimation (not sensor) ²	0.0 KPH	25.5 KPH	0.1 KPH	
1.2.10	Key Switch Hours Count	0 Hrs	65279.9 Hrs	0.1 Hrs	
1.2.11	Traction Pulsing Hours Count	0 Hrs	65279.9 Hrs	0.1 Hrs	
1.2.12	Node ^{Failed3}	Master, Slave, Pump, Low IO or High IO			
-	Service Log Reset	press + followed by - to reset service log			

Note 1: Log Info shows where the + and - keys can be used to access the service max and min data.

Note 2: Status information only applicable for dual traction motor systems

7.1.3 Traction Controller Test Information

Cal. Ref.	Input Displayed	Min. Display	Max. Display	Step Size
1.3.1	Accelerator % Range	0 %	100 %	1 %
1.3.2	Accelerator Voltage Range	0.00 V	5.00 V ³	0.02 V ³
1.3.3	Footbrake Pot. % Range	0 %	100 %	1 %
1.3.4	Footbrake Pot. Voltage Range	0.00 V	5.00 V ³	0.02 V ³
1.3.5	Economy Pot. % Range	0 %	100 %	1 %
1.3.6	Economy Pot. Voltage Range	0.00 V	5.00 V ³	0.02 V ³
1.3.7	Dual Motor Steer Pot Angle (°C). Range	-90°C	90°C	1°C
1.3.8	Dual Motor Steer Pot. V Range	0.00 V	5.00 V	0.02 V
1.3.9	Forward	Open	Closed	-
1.3.10	Reverse	Open	Closed	-
1.3.11	FS1	Open	Closed	-
1.3.12	Belly	Open	Closed	-
1.3.13	Seat	Open	Closed	-
1.3.14	Tiller	Open	Closed	-
1.3.15	Brake Over Ride	Open	Closed	-
1.3.16	Speed Cutback 1	Open	Closed	-
1.3.17	Speed Cutback 2	Open	Closed	-
1.3.18	Speed Cutback 3	Open	Closed	-
1.3.19	Inch Forward	Open	Closed	-
1.3.20	Inch Reverse	Open	Closed	-
1.3.21	Handbrake	Open	Closed	-
1.3.22	Power Steer Trigger Input	Open	Closed	-
1.3.23	Pump Trigger Input	Open	Closed	-
1.3.24	Dual Motor Inner Left	Open	Closed	-
1.3.25	Dual Motor Inner Right	Open	Closed	-
1.3.26	Dual Motor Outer	Open	Closed	-
1.3.27	Constant Speed	Open	Closed	-
1.3.28	Software Version/Revision Information	000.00	999.99	-
1.3.28A ²	Data Layer Version/Revision Information	000.00	999.99	-
1.3.29	Controller Serial Number Information	00000000	99999999	-
1.3.30	Controller Type Information	Refer to section 2		

Note 1: As with the personalities, only relevant switch and range tests will be shown determined by configuration.

Note 2: Press down (▼) from Software Version/Revision (1.3.28) to access this item.

Note 3: If this analogue input is configured on pin 10 on the MicropaK unit, the maximum value is 10.00V and the step size is 0.04V.

7.1.4 BDI Adjustments (if enabled in setup menu)

Cal. Ref.	Parameter Adjusted/Displayed	Min Setting	Max. Setting	Step Size.
1.4.1	xxx % Charge remaining	display only		
1.4.2	Reset x.xx V/Cell	2.00 V/Cell	2.50 V/Cell	0.01 V/Cell
1.4.3	Empty x.xx V/Cell	1.50 V/Cell	1.99 V/Cell	0.01 V/Cell
1.4.4	Warning xx %	0 %	90%	1.0 %
1.4.5	Cutout xx %	0 %	90%	1.0 %

7.1.5 Fault Log Can be disabled via setup menu. See section 9 for more details.

7.1.6 Traction Controller Setup Menu (Enables/Disables features)

Cal.Ref	Feature	Options
1.6.1	System Setup	<u>Standalone</u> / Master / Slave / Dual Traction / Traction + Pump / Dual + Pump
1.6.2	Digital IO	See Note 2

1.6.3	Analogue IP	See Note 2
1.6.4	Contacting Chopping	24 V / On / Off
1.6.5	Accelerator Type	Linear / Curved / 2* Slope/ Crawl
1.6.6	BDI	On / Off
1.6.7	Power Steer Trigger	None to FS1 +Dir+ Brake +Seat
1.6.8	Economy Cuts Traction Current	On / Off
1.6.9	SRO	On / Off
1.6.10	Braking	Proportional / Constant
1.6.11	Control Mode	Torque / Speed
1.6.12	Tiller Up Forward	On / Off
1.6.13	Fault Log	On / Off
1.6.14	Service Log	On / Off
1.6.15	Vehicle Full Speed	0.0KPH to 51.0KPH
1.6.16	Steer Reverse Enable	Yes / No
1.6.17	Roll Off E. Brake	On /Off
1.6.18	Battery Volt	24V to 96V (2V steps)
1.6.19	Seat & Pump	On / Off

Note 1: Changes only take effect after a key-switch recycle

Note 2: See appendix A for Digital IO and Analogue IP personality configurations.

7.1.7 Motor Setup Menu

Cal. Ref	Parameter Adjusted	Min adjust (all units)	Max. adjust (all units)	Step size (all units)	Typical Default (200A, 270A, 350A, 500A)			
1.7.1	Armature Current low	10A	50% of max	10 A	50 A (all units)			
1.7.2	Field Current low	2.00A	50% of max	0.25A	6.00 A (all units)			
1.7.3	Armature Current mid	Ia Low	Ia High	10 A	100 A	140 A	170 A	250 A
1.7.4	Field Current mid	If Low	If High	1 A	15 A	15 A	25 A	25 A
1.7.5	Armature Current high	50% of max	Maximum	10 A	200 A	270 A	350 A	500 A
1.7.6	Field Current high	50% of max	Maximum	1 A	30 A	30 A	50 A	50 A
1.7.7	Armature Resistance	0 mΩ	255mΩ	1mΩ	30mΩ			
1.7.8	Field Resistance*	0.25Ω	2.50Ω	0.01Ω	0.50Ω			

***Important Note:** The correct field resistance personality for the SEM motor must be entered at item 1.7.8 for the motor to be controlled correctly.

Cal. Ref	Feature	Options
1.8.1	Main Hours	Key / Drv / Pmp
1.8.2	Status	Off / Trac I / Trac V / Pump I / Pump V / KPH / MPH / Accel / Steer / Ver No /
1.8.3	Contrast	1 to 127 (increment steps of 1)
1.8.4	Ind 1	Off / Trac I / Trac V / Pump I / Pump V / KPH / MPH / Accel
1.8.5	Ind 2	Off / Trac I / Trac V / Pump I / Pump V / KPH / MPH / Accel / Steer
1.8.6	Fault Msgs	Off / On

7.2 Adjustment Descriptions

7.2.1 Traction Adjustment Descriptions

Adjustment	Description
Armature Current Limit	Maximum allowable motor Armature current.
Field Current Limit	Maximum allowable motor Field current.
Acceleration Delay	Time taken to ramp up from 0 to 100% on.
Deceleration delay	Time taken to ramp down from 100% to 0% on.
Creep Speed	Minimum applied % on when drive first selected.
Regen Direction Brake Current	Maximum Regen braking current during direction switch change. For Torque mode only.
Regen Direction Brake Time	Time for vehicle to stop during a direction change. For Speed Control mode only.
Regen Neutral Brake Current	Maximum Regen braking current in neutral.
Regen Footbrake Current	Maximum Regen braking current in neutral when F.brake switch active.
Regen Delay	Minimise delay between braking and drive commencing.
Regen Threshold Voltage	Armature voltage at which braking ends and drive commences.
Rolloff Field	Percentage of field current limit applied for plug braking when rolloff is detected.
Maximum Speed	Maximum allowable % on in Torque mode or speed in Speed Control mode.
Cutback Speeds 1, 2 & 3	Maximum allowable % on in Torque mode or speed in Speed Control mode when cutback switches active.
Accel. Delay 1, 2 & 3	Independently adjustable acceleration delays during speed cutbacks.
Inch Speed	Maximum allowable % on during inching operation.
Burst Inch Delay	Timer to allow inching for a set period only.
Power Steer Delay	Delay after power steer trigger removed until contactor opens.
Seat Switch Delay	Delay after seat switch opens until pulsing is inhibited.
Zero Levels	Used to select minimum voltage input level for function. E.g. an Accel Zero level=0.5V means traction pulsing begins at 0.5V I/P
Full Levels	Used to select maximum voltage input level for function, E.g. an Accel Full Level of 4.0v means 100% pulsing is reached at 4V I/P
Steer Center Level	Used to set the mid voltage point when the wheels are at 0 degree's i.e. the vehicle will travel in a straight line.
Dual.Motor Inner Angle	Sets start of inner motor cut band. Typically 45° for non-proportional systems and 10 ° for proportional systems.
Dual.Motor Outer Angle	Sets start of inner motor reverse band. Typically 75° for non-proportional systems and 50° for proportional systems.
Constant Speed	Drive at set speed when the Constant Speed input is configured and active. Only operates for controllers setup as speed controlled walkies.
Belly Delay	Time belly operation, drive in forward, remains active, irrespective of how long belly switch is closed. Only operates for controllers setup as a walkie
Speed Limit	Maximum speed when the controller is setup in speed control mode.
Speed Proportional	Proportional gain for traction speed control.
Brake Proportional	Proportional gain for braking speed control.
Speed Integral	Integral gain for traction speed control.
Brake Integral	Integral gain for braking speed control.
Low Voltage Init	Voltage at which controllers starts reducing the max available current limit to help reduce voltage drops
Low Voltage Cutback	Voltage at which current limit is reduced to 0
Protection Delay	Length of time the voltage can fall below the Low Voltage Cutback level for, before a fault is indicated. This helps prevent low voltage spikes tripping a low battery fault
High Voltage Init	Voltage at which controller reduces Regen braking to help prevent high generated voltages damaging the battery or controller.
High Voltage Cutback	Voltage at which contactors will open, to prevent high voltage damage.

7.2.2 BDI adjustment descriptions

BDI Adjustment	Description
Charge remaining	Displays remaining battery charge. Display only, no adjustments can be made.
Reset Volts/Cell	Sets the voltage at which the BDI resets to 100% at power up. E.g. the BDI will reset to 100% on a 48V system, with the reset adjustment set to 2.20 Volts per cell, if the battery voltage is above 52.8V. $(48V/2)*2.20V$
Empty Volts/Cell	Sets the voltage at which the BDI indicates the battery is fully discharged E.g. the BDI will eventually show 0% on a 48V system, with the empty adjustment set to 1.60 Volts per cell, if the battery voltage is below 38.4V. $(48V/2)*1.60V$
Warning Level %	Sets the discharged level at which the warning threshold is reached, at which point the remaining lit segments flash.
Cutout Level %	Sets the discharged level at which the cut-out threshold is reached, at which point all the segments flash together and the cut-out action, Pump cut-out and Traction speed 2 limit initiated.

7.2.3 Setup Menu Descriptions

Setup menu Option	Description
System Set Up	Standalone/Master/Slave/Dual Traction/Traction + Pump/ Dual + Pump – Set to Standalone for single traction motor operation, Master for single traction motor operation when there is a CANbus Display in the system (NOTE: CANbus displays do not include Standard and Full Feature Displays), Slave for all other system units not designated the Master, Dual for dual motor applications, Track + Pump for single traction and pump controller applications and Dual + Pump for dual traction and single pump applications.
Digital IO	See Appendix A
Analogue IP	See Appendix A
Contactors Chopping	24V/On/Off – Set to 24V to obtain 24V across coils when a lamp is also being driven, On when just contactor coils are being driven and Off when battery voltage contactor coils are used.
Accelerator type	Linear/Curved/2*slope/Crawl - Set to Linear for a straight line accelerator characteristic, Curved for more low speed manoeuvrability, 2*Slope for a balance between Linear and Curved, and Crawl for a very shallow low speed manoeuvrability curve. See graph 1.
BDI	On/Off - On enables the BDI (Battery Discharge Indicator) and any warning/cut-out settings, Off disables the BDI feature and removes the BDI setup menu display.
Power Steer Trigger	None / FS1 / Dir / F+D / Brake / F+B / D+B / F+D+B / Seat / F+S / D+S / F+D+S / B+S / F+B+S / D+B+S / F+D+B+S – These are the various triggers for power steer activation, FS1 or F = FS1 switch, Dir or D = Direction switch, Brake or B = Foot brake switch and Seat or S = Seat switch. e.g. setting to FS1 will trigger the power steer delay only when FS1 is close., whilst setting to F+D+B will trigger the delay when either FS1 or Direction or the Brake switches are closed.
Economy cuts traction current	On/Off - set to On for current limit to be reduced during economy or Off for just the standard acceleration delay increase.
SRO	On/Off - On = SRO enabled, Off = SRO disabled
Braking	Prop/Const - Prop = Direction braking level is proportional to accelerator position, Const = Direction braking is constant level.
Control Mode	Torque / Speed - Torque = Accel. demand acts as a torque demand, Speed = Accel. Demand acts as a speed demand.
Tiller Up Forward	On/Off - On =Vehicle can drive in the forward direction with the tiller up, Off = Normal tiller operation.
Digital Input Configuring.	Speed 1/Speed 2/Inch Fwd/Inch Rev/Handbrake/Pst.Trig/Inner/Outer - Skt B pins 6 & 7 can be configured to perform the above input functions.
Analog Input Configuring	Accel/Footbrake/Economy/Digital Skt B pins 10 & 11 analog inputs can be configured to perform the above input functions. One analog input can be used as a digital.
Contactors Output 2 configuring.	Pump / P.Steer / Brake / Remote LED Skt B pin 9 can be configured to perform the above Contactors output functions.
Fault Log	On/Off - On = Fault Log enabled, Off = Disabled and no display.
Service Log	On/Off - On = Service Log enabled, Off = Disabled and no display.
Full Speed	Maximum unladen vehicle speed. Reported speed will be proportional to this value. A reading of maximum unladen vehicle speed should be taken in torque mode via an independent means and the value entered.
Steer Reverse	Yes / No – Yes when inner motor reversal in turns is required (e.g. 3 Wheel Trucks). Set to No when no inner motor reversal in turns is not required (e.g. 4 Wheel Trucks).
Roll Off E. Brake	On/Off . On = Anti rolloff condition activates electric brake immediately. Off = rolloff operates as normal. . Only operates for controllers setup as walkies with electric brake.

Battery Voltage	24V to 96V. The nominal battery voltage
Seat & Pump	On/Off. On = if the pump contactor is already closed, open the pump contactor when the seat switch has been open for the Seat Delay personality. Off = if the pump contactor is already closed, leave the pump contactor closed regardless of the seat condition until the pump demand is removed.

7.2.4 Motor Setup Menu

Parameter Adjusted	Description
Armature Current low	Sets the range of Armature current, 0 to Ia(low), in which the Field Current low limit operates.
Field Current low	Sets the target Field current when Armature current is less than Ia(low). This value will affect the maximum speed of the unladen vehicle.
Armature Current mid	Intermediate value of Armature current, Ia(mid).
Field Current mid	Sets the intermediate Field current for the above Armature mid point.
Armature Current high	Sets the range of Armature current, Ia(high) to I(max), in which the Field Current high limit operates.
Field Current high	Sets the target Field current when the Armature current is more than Ia(high).
Armature Resistance	Armature resistance of the motor, in milli-Ohms, at 25°C
Field Resistance	Field resistance, in Ohms, at 25°C. This value MUST be entered for the motor to be controlled correctly. If the field resistance exceeds 1.60Ω, please contact Sevcon for further advice.

The motor setup menu allows the Armature current to Field current mapping graph (shown below) to be modified. The 6 settings above essentially define 3 points low, mid and high, which are interconnected by straight lines, which make up the mapping graph. The controller software uses the graph by measuring the Armature current, feeding it through the graph to obtain a target Field current.

This graph allows the controller to optimally control the motor, by setting a minimum Field current at low and high armature currents, as well as proving a mid range point to help tune the mid speed range /power ratio, useful when optimising the speed of gradient climbing versus motor heating.

7.2.4.1 Armature/Field Mapping Graph.

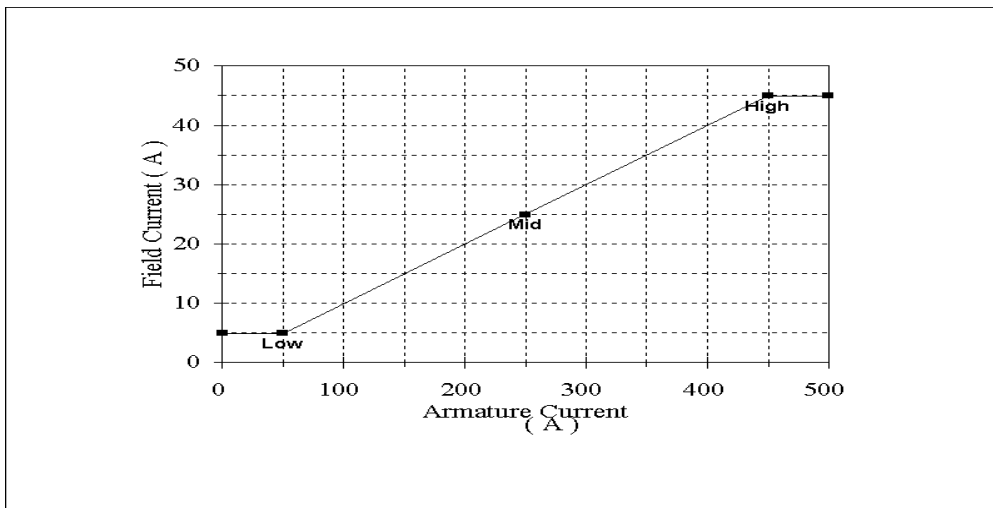

Traction and Pump Fault Messages and LED status/number of flashes

Calibrator Message	Standard Display	Full Feature Display	Led	Description and how to clear	Check...
OK (lowest priority)			on	Traction operational and OK.	No action required.
BDI Cutout	BDI Cut	BDI CUT OUT	7F	BDI enabled and cut-out action initiated.	Battery charged.
Thermal Cutback	Over Temp.	TRAC HOT	8F	Traction heatsink above 75°C. Allow controller to cool.	Heatsinking, Mounting, Surfaces clean, fan req.
Accel. Fault	Accel Fault	ACCEL FAULT	6F	Accel. pedal pressed at power up, or wire off. Recycle FS1 and Direction.	Accel wiring. Accel Zero & Full Personalities.
Steer Pot Fault	Steer Fault	STEER FAULT	6F	Wire off steer pot input.	Steer pot wiring
Belly Fault	Belly Fault	BELLY FAULT	2F	Belly Switch is active.	Check Belly Switch is open and check Belly Switch wiring.
Sequence Fault	Seq. Fault	SEQ FAULT	2F	Direction or FS1 switch at power up. Recycle Direction FS1 or both.	Dir and FS1 in neutral and Dir/FS1 wiring.
2 Dir. Fault	2 Dir Fault	2 DIR FAULT	2F	Two directions selected together. Recycle both Directions and FS1.	Direction switch wiring.
SRO Fault	SRO Fault	SRO FAULT	2F	Dir. switch selected > 2 seconds after FS1. Recycle FS1 and Dir.	Dir first then FS1, FS1 and Dir. switch wiring.
Seat Fault	Seat Fault	SEAT FAULT	2F	Drive selected and no seat sw. Recycle Dir and FS1 switch	Seat switch, closed, seat wiring.
Inch Fault	Inch Fault	INCH FAULT	2F	Inch switch at power up , both inch switches selected or inching attempted with seat switch or Dir/FS1 selected. Recycle inch switches.	Inch switch in neutral at power up ,only 1 selected, Seat/Dir/FS1 switches open.
Steer Fault	Steer Fault	STEER FAULT	2F	Outer switch closing before inner.	Switch operation/wiring.
Battery Low	Bat. Low	BATTERY LOW	7F	Battery < Low battery personality. Recycle FS1 or Direction switch	Correct battery voltage, Discharged battery.
Battery High	Bat. High	BATTERY HIGH	7F	Battery > High battery personality. Recycle FS1 or Direction switch	Correct battery voltage. Loose or missing B+ to controller.
Pers Error	Pers Error	PERS ERROR	1F	Personalities out of range at power up.	Reset personalities out of range (shown as ----.-).
CRC error	CRC Error	CRC ERROR	1F	One or more personalities have been corrupted.	Check all personalities then recycle keyswitch.
Coil s/c	Coil s/c	COIL FAIL	9F	A contactor coil s/c or miswired. Recycle Keyswitch	Coil s/c, Drive connected directly to B+ve, wiring.
Mosfet s/c	FET s/c	MOSFET FAIL	3F	MOSFET s/c Recycle FS1 or Direction	A / F1 / F2 / B- power wiring, MOSFETs s/c.
Line Cont O/C	Fail	FAIL	4F	Line Contactor did not close.	Check Line Contactor coil wiring
PUp Trac Weld	Fail	FAIL	4F	Line Contactor welded shut	Check Line Contactor
PUp Trac MOS	Fail	FAIL	3F	MOSFET s/c Recycle FS1 or Direction	A / F1 / F2 / B- power wiring, MOSFETs s/c.
EEPROM Fault	Fail	FAIL	1F	Internal Memory fault	Contact Sevcon
CANbus Fault	CAN Fault	FAIL	12F	Node on CANbus not communicating	Check CANbus wiring
Various internal controller power up messages (highest priority)	FAIL	FAIL	off	If any of these message are displayed then the controller has failed one of its internal power up checks.	Contact Sevcon.

9 SERVICE AND FAULT LOGS

The Service and Fault Logs have been incorporated to allow end users and service personnel to inspect and note the controller's performance and fault history. Utilising the controller's existing Status measurements and Diagnostics capabilities, information (such as the maximum temperature the controller has operated at or the number and type of faults that have been detected) can be stored in non-volatile memory and presented at a later date,. Both the Service and Fault logs can be selected/deselected via the setup menu on the calibrator, and when selected can be cleared at any time to start recording new data.

9.1 Service Log

Service information is available in the Traction and Pump Status menus, where holding down the '+' key shows the maximum value of the current item, and holding down the '-' key shows the minimum value. The following items are logged:

- Maximum Battery Voltage
- Maximum Motor Armature Current
- Maximum Motor Field Current
- Maximum Controller Temperature and Minimum Controller Temperature.

To clear the log, access the "Service Log + to reset log" message at the end of the Status menu, and follow the prompts. The service log can be enabled and disabled in the Setup menu.

9.2 Fault Log

The Fault log is available at location 1.5 on the calibrator. Faults are grouped together by "LED flash fault"; the types of flash fault and whether each is logged is shown below. Generally faults that can occur during normal operation e.g. a 2 flash driver procedure error or an 8 flash thermal cutback indication, are not logged.

- | | | |
|-------------------|------------|--|
| - LED off faults | Logged | (Internal controller power up check faults) |
| - 1 flash faults | Logged | (Personality/CRC faults) |
| - 2 flash faults | Not Logged | (Driver procedure/sequence/wiring type faults) |
| - 3 flash faults | Logged | (MOSFET/Motor wiring type faults) |
| - 4 flash faults | Logged | (Contactor o/c or s/c or wiring type faults) |
| - 5 flash faults | Not Logged | (Not used) |
| - 6 flash faults | Not Logged | (Potentiometer wire off type faults) |
| - 7 flash faults | Logged | (Battery low or high faults) |
| - 8 flash faults | Not Logged | (Thermal cutback faults) |
| - 9 flash faults | Logged | (Contactor coil s/c type faults) |
| - 12 flash faults | Not Logged | (CAN bus faults) |

Each of the above logged categories contains - The total number of faults of this type, the Key hours count of the most recent fault and a text description of the fault. An example of how the Fault Log information is presented is shown below:

12*04F 12345.6hr Contactor o/c

This display shows that 12 4-Flash faults have occurred and been logged, the most recent at 12345.6 Key hours and it was a Contactor o/c fault.

Once into the fault log menu, the left and right arrows are used to view any faults stored and at the end of the list a "Fault Log + to reset log" message is shown, where the Fault Log can be reset in a similar way to the service log. The Fault Log can be enabled and disabled in the setup menu.

10.1 TRACTION OPERATION - Applicable to all Traction logics unless otherwise specified

- 10.1.1 **Start Up Sequence** - At keyswitch on, the Direction and FS1 switches must be in the neutral condition simultaneously at least once before drive can be selected. This is a safety feature to help prevent unexpected movement immediately after power up.
- 10.1.2 **SRO** (Static return to off)- This feature is optional in the setup menu and when specified, forces the following sequences of switch inputs to be followed before drive is allowed: Keyswitch-Direction-FS1 or Keyswitch-FS1-Direction (within 2 seconds of FS1) . Any other sequence will not allow drive. Drive will be inhibited if FS1 is active for more than 2 seconds with no direction selected. In this case the FS1 will need to be recycled.
- 10.1.3 **Seat Switch** - If the seat switch is opened and the seat switch timer has timed out during drive the controller will stop pulsing and a seat fault will be indicated. Before drive can be restarted the seat switch must be closed, and FS1 and the direction switch must be recycled through neutral. Note the start sequence for drive requires that the seat switch is closed and both the direction and FS1 switches are in the neutral position simultaneously before drive can be initiated. The time period is programmed by means of the Calibrator (Seat Switch Delay). As a setup menu option the seat switch can also inhibit pump operation if required.
- 10.1.4 **Belly Switch** - A Belly Switch function is available when the controller is used on a walkie type truck. The feature can be enabled in the setup menu. See this section and wiring diagrams for additional information. Basic operation is as follows:-
- Truck moving in Reverse and activating the Belly Switch, accelerator in reverse position:-
- The controller initiates braking at the maximum current limit, independent of personality settings.
 - 150% maximum braking is applied for a maximum of 1.5 seconds, when it will then revert to maximum braking.
 - The vehicle will accelerate at full speed along the accelerator curve.
 - All drive will cease after a period defined by the Belly Delay personality from the start of (c) above.
 - The controller will wait for neutral to be selected before drive will operate. If the Belly switch is pressed again however, action as at c) above.
- Accelerator in Neutral:- As above
- Accelerator in Forward position: Start at c) above
- Truck moving in Forward and activating the Belly Switch, accelerator in forward position:-
- Accelerator in Forward position: No effect
- Accelerator in Reverse position: Belly switch closed, truck drives as per start of c) above.
- Other options available.
- 10.1.5 **Handbrake Switch** - An input is provided for the connection of a handbrake switch, which if operated will disable armature pulsing but leave a low level field current to effect a minimum roll back hill start when drive is selected and the handbrake is released.
- 10.1.6 **Deceleration Delay** – In Torque mode, this is an adjustable delay to ramp down the pulsing from 100% on to 0% on, and can be used to limit the inherent truck lurch when acceleration is interrupted. In Speed Control mode, this is the ramp down rate of the speed demand when neutral is selected or the accelerator demand is reduced.
- 10.1.7 **Creep** - The Creep speed is adjustable and is used to select a minimum pulsing level as soon as drive is requested, to minimise delays and dead-bands. The motor voltage is rapidly ramped to the creep level (equivalent to a 100mS acceleration delay).
- 10.1.8 **Cutback speeds** - There are 2 cutback switch inputs as standard. An additional cutback 3 function can be configured in the Setup Menu. Each one has an associated personality to adjust the maximum % on, in Torque mode or the maximum speed in Speed Control mode, when the switch is active, and an independently adjustable acceleration delay to further enhance low speed manoeuvrability. When both switches are active together, the lower speed is selected together with the slowest acceleration delay. The cutback speed inputs are usually normally closed so that a wire off type fault or bad connection initiates a lower speed.

When the BDI feature is enabled and the cut-out level is reached the speed 2 cutback is automatically initiated.

A maximum speed adjustment is also available to limit the maximum applied %on, in Torque mode or speed in Speed Control.

10.1.9 **Power Steer** - A contactor drive is available to control a separate Power Steer motor. An adjustable delay allows the motor to operate for a set time, after the power steer trigger or power steer demand has been removed. SEVCON's standard trigger, i.e. when the contactor is closed, is when either FS1 or the Footbrake switch is closed, or the Traction unit is pulsing. It is an either-or situation, so any one of these 3 inputs is sufficient to trigger the Power Steer.

This standard trigger is designed to give power steer when ever the truck is moving, but not to have a situation where the Power steer could be on continuously, i.e. on a direction switch where the truck could be left with a direction selected and the Keyswitch left on. If FS1 or the Footbrake is applied then the vehicle is either about to move or is moving, and the Traction pulsing is used if the truck was neutral braking (pulsing) down a long ramp, when it is conceivable that neither of the 2 switches would be closed. On a tow-tractor, power steer is disabled during inching.

An independent input pin (see figures 2 & 3) also exists to trigger Power Steer operation. This is normally used in conjunction with a steer on demand system where an output is generated when the steering wheel is turned. This gives Power steer on demand and is more efficient since typically no steering delay, or only a short delay is needed.

The independent trigger only, or other trigger combinations can be configured if necessary in the setup menu.

Some vehicles derive the power steering assistance from the main Pump Hydraulic motor, instead of having a separate Steer motor. In this situation the trigger is fed to the Pump controller and runs the pump at the speed set by the Power Steer Speed personality.

Independent ramp up and ramp down delays are provided when Power steer assistance is derived from the main Pump controller, to help tune steering responsiveness without affecting the main pump operation.

10.1.10 **Regen Braking** -Regen provides vehicle braking by controlling the motor as a generator and returning the generated energy back to the battery. Regen braking reduces motor heat dissipation compared with plug braking. Regenerative braking can be initiated in 3 ways, each with an independently adjustable braking level, as follows:

- i) A direction switch change will initiate Regen braking at a fixed level set by the Direction Brake Current level in Torque mode or, in Speed Control mode, a calculated level to bring the vehicle to a stop in the Direction Brake Time. In Torque mode, braking effort can be proportional to the accelerator position, with a minimum accelerator pedal position giving 50% of the set brake level increasing to 100% for a fully depressed pedal. The proportionality range allows the driver to modify the braking effort without allowing freewheeling. The proportionality feature is optional and can be configured in the setup menu to give fixed braking at the set personality level.
- ii) Closure of the foot-brake switch in neutral, will initiate Regen braking at the Footbrake personality level. An input is provided to allow braking effort to be proportional to the Footbrake position if a potentiometer is fitted. Setting a 0 into the personality disables braking on the Footbrake switch.
- iii) When neutral is selected, Regen is initiated at the Neutral Brake Current level in Torque mode or, in Speed Control mode, a calculated level to bring the vehicle to a stop in a time determined by the Deceleration Delay. In Torque mode, setting a 0 into the personality disables neutral braking and allows freewheeling.

Regen braking is attempted at all speeds. To help minimise delays attempting to Regen, a Regen Time adjustment is offered which can be set so that Regen is only attempted for a short period of time. The time should be sufficient to initiate Regen at medium to high speeds but not to cause unnecessarily long delays at very slow speeds where Regen is not possible. If the Regen Time setting is increased then Regen can be initiated at lower speeds. Setting the Regen Time to 0 gives the most abrupt turn-around.

If Regen is not possible due to low vehicle speed, the following action will be taken:

- 1) For direction braking, drive will be initiated in the new selected direction.
- 2) For neutral or footbrake braking, the vehicle will freewheel.

The switching frequency in Regen is high frequency and silent.

- 10.1.11 **Inching** - This facility is normally used on Tow Tractors to manoeuvre the Tractor towards the load from the rear of the vehicle, using 2 inching buttons, one for forward and one for reverse. The inch speed is adjustable via the calibrator.

Inching will only operate if the main direction control and FS1 switches are in the neutral position and the seat switch is open, and handbrake off. These safety interlocks prevent anyone from sitting in the driver's cab whilst an operator is using the inching switches at the rear.

A burst inching feature is also available which uses inching in conjunction with an adjustable timer to provide inching for a limited period. This is typically used in conjunction with an electromechanical brake to provide inching on gradients and to help prevent against unlimited travel if an inching button became jammed in the closed position or failed short circuit.

- 10.1.12 **Anti-Rollback** - This is a standard SEVCON feature and is used to help prevent roll back conditions on ramps. If the driver reselects the previous direction after a neutral condition, maximum controller braking is available to stop the truck from rolling back, and full drive power is available to restart on a hill

- 10.1.13 **Anti-Rolloff** - This feature is designed so that if a vehicle is in a non-drive condition on a gradient, it will result in the vehicle plug braking slowly down a ramp without running away. When rolloff is detected, the field direction is selected to ensure that plug braking occurs and applies the level of field current determined by the Rolloff Field personality (i.e. Rolloff Field percent of the Field Current Limit). The rolloff speed can be altered by changing the Rolloff Field percentage personality. 0% will result in the vehicle free-wheeling while 100% will cause the slowest possible rolloff speed.

- 10.1.14 **Analogue Inputs** - The accelerator/analogue inputs are flexible in the range of signal sources they can accommodate and can be adjusted to minimise dead-bands and mechanical tolerances. Each analogue input has 2 adjustments associated with it to allow the input voltage range to be determined.

For the Traction Accelerator, for example, the 2 adjustments are called the "Accelerator Zero Level" and the "Accelerator Full Level". If these were set to 0.20V and 4.80V then 0% pulsing would start at 0.20V at the input, increasing to 100% pulsing at 4.80V. For accelerators with decreasing voltage outputs, the Zero adjustment might be set to 3.5V and the Full adjustment to 0.0V. The Calibrator test menu shows the instantaneous voltage reading, and the equivalent % "push" for each input, and to allow easy set-up, pressing the "down" key on the calibrator from either of these test displays, allows a direct jump to the Zero voltage and Full voltage personality settings. Note that a 6 flash fault will occur if the full and zero levels are set within 0.50V of each other.

Pin 10 on the MicropaK unit has a range on 0.00V to 10.00V. This allows the input to be used with a potentiometer connected to the 12V output on the customer connector.

For wiring details see Figures 1 to 3.

- 10.1.15 **Traction Accelerator** - The Traction Accelerator is used to demand the required percentage on in Torque mode, or the required speed in Speed Control mode. In Torque mode, 0 to 100% accelerator gives a percentage on from the Creep Speed personality to the Maximum Speed personality. In Speed Control mode, 0 to 100% accelerator gives a speed from zero to the Maximum Speed personality.

If the accelerator is depressed at power up, pulsing will be inhibited and a 6 flash fault will be indicated, until the pedal is released. In case of a wire off type fault, pulsing will be limited to the creep setting and a 6 flash fault will also be given.

Various accelerator characteristics i.e. relationship between accelerator push and the applied motor voltage or speed demand, can be selected via the setup menu. There are 4 options: Linear, Curved, 2*slope and Crawl. Set to Linear for a straight line accelerator characteristic, Curved for more low speed manoeuvrability, 2*Slope for a balance between

Linear and Curved, and Crawl for a very shallow low speed manoeuvrability curve. See graph 1.

- 10.1.16 **Footbrake Potentiometer** – This input is available to allow a potentiometer to be fitted to the Footbrake pedal for proportional braking. It can be connected and set-up as per the accelerator input.
- 10.1.17 **Economy Potentiometer** - This potentiometer, normally available to the driver of the truck, varies the acceleration ramp delay from its set value to its maximum value. It can be adjusted as per the accelerator input. As a setup menu option the economy function can reduce the traction current limit, instead of increasing the acceleration delay. .
- 10.1.18 **Steering Potentiometer** – For Dual Motor traction applications, a steering potentiometer can be feed into pin 11 on the Slave controller.
- 10.1.19 **Digital Switch Inputs** - The digital inputs on the controller are configured as Active Low inputs, where the switches are wired to B-ve. Active High inputs, connecting to B+ve, are not available. The SEVCON standard is Active Low, and is recommended for its low impedance input stage and immunity to moisture related problems.

Switches are normally open, with the exception of the speed cutback switches which are normally closed, so that a wire off or bad connection initiates the cutback speed, rather than a higher speed.

- 10.1.20 **Contactors** - There are 2 contactor drives rated at 2A maximum. One is dedicated to a Line contactor function, whilst the other can be configured to be either Power Steer or an Electric Brake drive for Walkies, or as an external LED drive.
- 10.1.21 **Contactor chopping** - This feature allows 24 V contactors to be used at all battery voltages 24V - 80V, by continuously monitoring the battery voltage and chopping the contactor output pins accordingly, to present an average voltage suitable for 24V coils. Chopping is selectable by the calibrator. All the contactor drives will be either chopped or not chopped. It is not possible to select individual drives to chop. Care must be taken to ensure that chopping is always selected if 24V contactors are being used on battery voltages higher than 24V. In applications > 24 volts contactors must be fitted with blow out magnets.

Chopping can reduce the overall dissipation in the coils and allows only one set of contactors to be stocked for all battery voltages.

Chopping Frequency approx. = 650Hz (Slightly audible at higher battery voltages)

Typical contactor coil voltage during chopping = 16 volts.

Typical contactor coil voltage during energisation = 24 volts for 1 second.

There are 3 contactor chopping options available via the setup menu: Off, On and 24V. The off setting is used for nominal battery voltage coils, and the On setting is for 24V coils on higher voltage vehicles. Setting to 24V provides chopping for 24V coils and lamps without the drop to 16V after 1s.

- 10.1.22 **Fail-safe** - The controller's safety system includes a microprocessor watchdog which can detect software failure, and a hardware fail-safe system which can prevent dangerous runaway conditions in the event of certain hardware failures.

Every time the controller is powered-up, the software checks that the fail-safe circuit is able to switch off the MOSFETs and open the contactors.

- 10.1.23 **Dual Motor Proportional Operation - General Principles** - Using the CAN bus a Dual Motor SEM Traction system can be implemented with or without Pump controller, and with or without Sevcon's CAN input module. With SEM the traction dual motor system is always implemented with 2 controllers in a Master /Slave arrangement.

Depending on the steering angle, the inner motor of a turn can be reduced in speed, and then reversed if required. For increased safety, the overall speed of the vehicle can also be reduced as it turns.

The steering information can be provided by either 3 switch inputs (inner-left steer switch, inner-right steer switch and the outer switches connected in parallel) or a steer potentiometer. Sevcon recommends a steer pot., as this allows linear inner-wheel control and linear speed cutback in turns on all vehicles. As the steering characteristics for a potentiometer can be adjusted via the calibrator (items 1.1.28, 1.1.29 and 1.1.30),

mechanical adjustment is not required. See section 7.1.1 for typical values. The inner angle and outer angles personalities must be at least 5° apart. If problems exist with setting the values, check the other setting to ensure it is not within 5 degrees.

For all dual motor systems, the steering range 0 - 90° is split into 3 sections: the dead-band, the cut-band and the reverse-band. The characteristics of each are shown below:

Band	Definition for Steer Pot.	Definition for Steer Switches	Maximum Vehicle Speed	Inner Motor Speed	Inner Motor Direction	Bypass & Field Weakening
Dead Band e.g. 0° - 10°	steer angle is less than inner angle	all steer switches open	100%	100%	Same as direction lever	Enabled
Cut Band e.g. 10° - 70°	steer angle is between inner and outer angles	one inner switch is closed	Reduced to cutback speed #1	reduced to 0%	Same as direction lever (or stationary)	Disabled
Reverse Band e.g. 70° - 90°	steer angle is greater than outer angle	one inner and outer switch is closed	Reduced to cutback speed #2	increased to cutback speed #2	Opposite of direction lever	Disabled

10.2 GENERAL OPERATION

10.2.1 **Operating Frequency** - The pulsing frequency for both Armature and Field is 16KHz for both drive and regen braking and gives silent operation.

10.2.2 **Temperature Monitoring** - If the temperature of either power frame exceeds 75°C its maximum available armature and field current will be reduced. Note, however, that if the set current limit is less than the maximum available current limit actual cutback will occur at progressively higher temperatures than 75°C. The armature current and field current are cutback at different temperatures. The field current does not need to be reduced until much higher temperatures than the armature current. (See Graph 2). When actual cutback occurs the diagnostic LED will flash 8 times.

10.2.3 **Safe Operating Area (SOA)** - The controller's current may be limited at high and/or low duty cycles depending on its current and voltage specification. This is to reduce the thermal stress on the power components in order to increase long term reliability. See Graph 3.

The "Safe Operating Area" is a characteristic of the MOSFETs and Freewheel Diodes which make up the power-frame. The MOSFET SOA restricts current at high duty cycles on all configurations, and the Diode SOA tends to restrict the current at lower duty cycles on lower voltage applications.

For most applications SOA will have little or no effect on the operation of the controller. Its effect is more significant in protecting the controller against adverse loads such as damaged motors and static test rigs.

Future releases may incorporate alternate power curves to limit the maximum deliverable power at higher speeds and hence reduce energy consumption and motor temperature, while continuing to offer the peak required torque at a lower speed. The disadvantage of introducing such a power curve is to reduce laden vehicle speed particularly ramps.

10.2.4 **Under-voltage and over-voltage protection** - In order to prevent a sudden loss in power, the controller will begin to linearly ramp down the current limit, once the average battery voltage falls below a pre-set under-voltage start level. The current will be ramped down to 0 and a 7 flash fault indicated if the averaged battery voltage falls below the under-voltage cut-out level.

To protect the controller from over-voltage caused by prolonged regen braking, regen braking will be reduced when the average battery voltage reaches the over-voltage start level. If the voltage exceeds the over-voltage cut-out level in braking then the line contactors will open and freewheeling will occur, requiring the vehicles foundation brakes to be used.

Under any other circumstances if the battery voltage exceeds the over-voltage cut-out level, all pulsing is stopped and a 7-flash fault is indicated. This protects against incorrect battery connection.

Nominal Battery Voltage	Under-voltage Cutout	Under-Voltage Start	Over-voltage Start	Over-voltage Cutout
24 V	14.5 V	18.0 V	40.0 V ¹	45.0 V ¹
48 V	29.0 V	36.0 V	65.0 V	70.0 V
80 V	43.0 V	60.0 V	95.0 V	100.0 V

¹ For 24-36V MicropaK controllers, **DO NOT** configure the over voltages above the recommended limits as damage to the controller will occur.

10.2.5 **Diagnostic LED** - This is mounted between the connectors on the front of the controller. It serves as a simple diagnostic tool as explained below:

Constant illumination	- No fault, normal condition
LED extinguished	- Internal controller fault
1 flash	- Personality out of range
2 flashes	- Illegal start condition or illegal steer switch inputs.
3 flashes	- MOSFET Short Circuit
4 flashes	- Contactor fault or Motor Open-Circuit
5 flashes	- Not used
6 flashes	- Accelerator, Steer Pot or Speed Probe wire off fault
7 flashes	- Low or High battery voltage or BDI cut-out operating
8 flashes	- Over temperature
9 flashes	- Contactor coil s/c
12 flashes	- CAN bus fault

Further explanation of the LED flashes is displayed on the calibrator fault message section.

10.2.6 **Fault Clearance** - Any fault indication will be cleared by re-initiating the start sequence after the cause of the fault has been removed.

10.2.7 **Software Version and Revision indication** - For identification purposes and to assist in queries, the Software version and revision, and the controller serial number are indicated in the calibrator Test Menu.

10.2.8 **Dashboard Displays** - SEVCON's existing CAN based standard and full feature displays are compatible with PowerpaK and MicropaK controllers.

10.2.9 **Setup Menu** - A setup menu has been added to the Calibrator that allows various features to be enabled and disabled. See section 7 for more information.

Note. Once a change has been made to the setup menu, the Key switch must be recycled for the change to be operational.

10.2.10 **Multi Languages** - Non-English languages can be specified for displaying on the Calibrator. Languages can be presently specified as either English, German, Spanish, Italian or French.

11 DASHBOARD DISPLAYS - OPERATION AND FEATURE DESCRIPTIONS

SEVCON offers 2 dashboard mounted CAN (Controller Area Network) Displays for any SEVCON controller equipped with serial CAN communications, including the PowerpaK range. A standard display offers a compact design compatible with 2" dashboard hole mounting, and a full-feature display offers a higher specification LCD. Both are back-lit for use in low ambient light conditions.

Both displays have BDI Indication. and 3 hours-counters. The hours counters are retained in the display in the event of the controller or the controller's logic being replaced in the field.

11.1 STANDARD DISPLAY

The unit consists of a 2x16 alphanumeric LCD display housed in a standard 50mm circular plastic case, with a rectangular front facia. The display incorporates a 10 segment BDI (Battery Discharge Indicator), a 6 digit hours counter and a 10 character area for diagnostic and status messages. When there are no diagnostic messages the area can be used to indicate a variety of system status readings.

11.1.1 STANDARD DISPLAY FEATURES.

- * One unit for 24V-96V.
- * Standard 50mm circular case with rectangular front facia, enclosed to IP65
- * Alphanumeric display 2x16 characters.
- * Readily understandable display format consisting of numbers, text and segments.
- * 10 segment BDI indication, with low charge warning and cut-out warnings.
- * 10 character text based diagnostic/status display.
- * 6 digit hours counter with 0.1 hour indication, and flashing "egg timer" counting symbol.
- * Capable of counting up to 99999.9 hours. Equates to 34 years @ 8 hour shift per day
- * Keyswitch, Traction and Pump hours count can be shown, identified as K, T, P.
- * Hours count retained in display in the event of a controller or logic replacement.
- * Display connected via single cable, no external power connections necessary.

Display example showing diagnostic message



11.1.2 STANDARD DISPLAY TECHNICAL SPECIFICATIONS

11.1.2.1 Environmental

Protection (front face):	IP65
Protection (rear):	IP34
Vibration:	6G, 0-150Hz for 1 hour
Operating Temperature:	-5°C to +50°C
Storage Temperature:	-40°C to +85°C
Humidity:	95% maximum, non-condensing
Humidity Resistance:	No functional defects after display is left at 60°C and 100% humidity for one hour after freezer use (-30°C minimum).

11.1.2.2 Mechanical

Mounting Hole:	2" Nominal. (See mechanical drawing)
Unit weight:	0.12 Kg (including mounting bracket)
Enclosure:	Injection moulded plastic case, with transparent front facia.
Connections:	One 6 way AT socket.
Fixings method:	Mounting bracket supplied

11.1.3 Electrical

Power Supply:	Derived from CANbus
Supply Current	60mA (typical)

11.2 FULL-FEATURE DISPLAY

The unit consists of a custom graphic LCD display housed in a SEVCON designed rectangular plastic case. The display incorporates a 10 segment BDI (Battery Discharge Indicator), a 6 digit hours counter and a 14 character area for diagnostic and status messages. The display has 11 warning symbols which can be lit by the controller (via the CANbus) or by 8 active low switch inputs. When there are no diagnostic messages the top line of the message area can be used to indicate one of a number of status readings (see “display related adjustments” below). In addition there are two multipurpose indicators, that can be reprogrammed using the calibrator to show one of a selection of system status readings.

11.2.1 FULL-FEATURE DISPLAY FEATURES

- * One unit for 24V-96V.
- * SEVCON-designed full-custom LCD with LED backlight.
- * Readily understandable display format consisting of numbers, text and segments.
- * 10 segment BDI indication, with low charge warning and cut-out warnings.
- * 14 character text based diagnostic/status display.
- * 6 digit hours counter with 0.1 hour indication, and flashing “egg timer” counting symbol.
- * Capable of counting upto 99999.9 hours. Equates to 34 years @ 8 hour shift per day
- * Keyswitch, Traction and Pump hours count can be shown, identified as K, T, P.
- * Hours count retained in display in the event of a controller or logic replacement.
- * Speed indication (indicator #2), can be reprogrammed via calibrator.
- * Text status area can show one of a selection of system status readings.

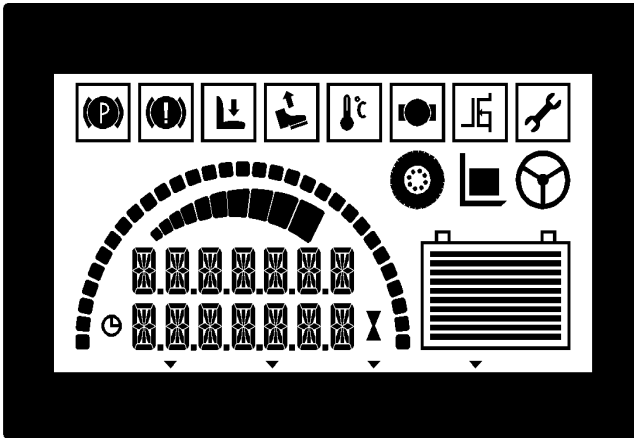

Full Feature Display with all segments lit.

11.2.2 FULL-FEATURE DISPLAY TECHNICAL SPECIFICATIONS

11.2.2.1 Environmental

Protection:	The enclosure is protected to IP65
Vibration:	6G, 40-200Hz for 1 hour
Operating Temperature:	-20°C to +70°C
Storage Temperature:	-40°C to +85°C
Humidity:	100% maximum, with condensing

11.2.2.2 Mechanical

Mouting hole:	128mm x 87mm (see mechanical drawing)
Unit weight:	0.35 Kg.
Enclosure:	Injection moulded plastic case, with transparent front facia.
Connections:	One 6 way AT socket, One 12-way.
Fixings method:	Mounting bracket supplied

11.2.2.3 Electrical

Power supply:	Derived from CANbus
Supply current:	60mA (typical)
Backlight supply	14.5V to 150.0V
Backlight supply current	50mA (typical)

11.2.2.4 12-Way Connections

<u>Pin</u>	<u>Type</u>	<u>Description</u>
1	Digital i/p	Traction Motor Temperature Warning
2	Digital i/p	Pump Motor Temperature Warning
3	Digital i/p	Power Steer Motor Temperature Warning
4	Digital i/p	Traction Motor Brush Wear
5	Digital i/p	Pump Motor Brush Wear
6	Digital i/p	Power Steer Motor Brush Wear
7	Digital i/p	Oil Warning
8	Digital i/p	Diagnostic/Service Warning
9	0V	Return for swtich inputs, pins 1-8
10	PSU i/p	Battery negative (backlight supply)
11	spare	
12	PSU i/p	Battery positive (backlight supply)

11.3 DISPLAY RELATED ADJUSTMENTS

11.3.1 Hours counter, Display status and Contrast adjustments (On pump only systems located in Pump sub menu 2.8)

Cal. Ref.	DISPLAY Parameter Adjusted	Minimum or default setting.	Maximum or other settings.	Step size.
1.9.1	Main Hours	Key	Drive, Pump	n/a
1.9.2	Status	Off	Ver #	n/a
1.9.3	Contrast (standard only)	0	127	1
1.9.4	Indicator 1 (FFD Only)	Off	Ver #	n/a
1.9.5	Indicator 2 (FFD Only)	Off	Ver #	n/a
1.9.6	Fault Messages	On	Off	n/a

1.9.1 The main hours adjustment is used to select which of the hours counters: Keyswitch (“K”), Traction (“T”) or Pump (“P”) hours, remains on the display after power-up sequencing, Normally this is Key (“K”).

1.9.2,4,5 Selects a system status reading for display (or indication on the full-feature display) from: Off, Traction motor current, Traction motor voltage, Pump motor current, Pump motor voltage, vehicle speed in KPH, vehicle speed in MPH, Accelerator pushes and display software version number (not available on indicator 1 or 2).

1.9.3 Sets the contrast of the standard display.

11.3.2 BDI adjustments

Cal. Ref.	BDI Parameter Adjusted or displayed	Minimum setting or displayed value	Maximum or other settings	Step size
1.4.1	xxx % Charge remaining	n/a	n/a	n/a
1.4.2	Reset x.xx V/Cell	2.00	2.50	V/Cell
1.4.3	Empty x.xx V/Cell	1.50	1.99	V/Cell
1.4.4	Warning xx %	0%	90%	1.0 %
1.4.5	Cutout xx %	0%	90%	1.0 %

WARNING: The BDI Empty level must be set in accordance with the specification of the battery fitted to the vehicle. Setting the Empty level lower than the battery manufacture’s specified discharged level can result in permanent damage to the battery.

1.4.1 Displays the remaining battery charge. No adjustments can be made.

1.4.2 Sets the voltage at which the BDI resets to 100% at power up. E.g. the BDI will reset to 100% on a 48V system, with the reset adjustment set to 2.20 Volts per cell, if the battery voltage is above $52.8V = (48V/2)*2.20V$.

1.4.3 Sets the voltage at which the BDI indicates the battery is fully discharged E.g. the BDI will eventually show 0% on a 48V system, with the empty adjustment set to 1.60 Volts per cell, if the battery voltage is below $38.4V = (48V/2)*1.60V$.

1.4.4 Sets the discharged level at which the warning threshold is reached, and the unlit segments flash.

1.4.5 Sets the discharged level at which the cut-out threshold is reached. All BDI segments flash, pump operation is cut, and cutback 2 is applied to traction.

11.4 BDI OPERATION

The state of battery charge is indicated by 10 segments on the display. When the battery is deemed fully charged, all 10 segments will be lit. When the battery is deemed fully discharged all segments will be extinguished, with each 10% drop in capacity extinguishing 1 segment. There are 4 adjustments associated with the BDI as described on the previous page, adjustable by the hand held calibrator.

When the battery charge drops below an adjustable warning level, typically set to 30%, the remaining lit segments will flash to warn the driver of this. When the charge drops further to below an adjustable cut-out level, typically 20%, all 10 segments will flash. At the cut-out level, Pump operation will be inhibited at the end of its present operating cycle, and cutback 2 personalities will be applied to the Traction.

The state of battery charge is retained even when power is removed, and is stored in the controller's non-volatile EEPROM memory. At power up the display will always indicate the previous state of charge for approximately 1 second, whereupon it will either continue to display this, or revert to a fully charged indication if the battery is deemed to have been charged in the meantime. The BDI system uses an averaged, accurate battery voltage to deduce the state of charge.





11.5 HOURS COUNTER (INDEPENDENT FROM CONTROLLER HOURS COUNT)





















A 6 digit hours counter is provided to indicate Traction pulsing, Pump pulsing and Key switch hours. The last digit displays tenth's of hours, i.e 6 minute intervals, with the counter capable of displaying up to 99999.9 hours in total. As a guideline, this is equivalent to approximately 34 years operation if the truck was used for an 8 hour shift every day.

At power up the hours count display initially indicates Key switch hours for approximately 3 seconds, followed by Pump pulsing hours for 3 seconds (if applicable), followed by Traction pulsing hours which remains permanently displayed. This order can be changed using the calibrator as described on the previous page. When the hours are being counted, a flashing egg timer symbol is displayed to indicate this. Hours counting accuracy is approx. +/- 2%. The display has its own integral non-volatile memory to retain all the hours counts in the event of the controller or controller logic being replaced.

11.6 DIAGNOSTIC/STATUS TEXT MESSAGES

The controller can transmit text messages for diagnostic and status indication. On the standard display these appear over the status area, and on the full-feature display, they also overwrite the hours counter until the fault condition has cleared. This feature can be disabled via personality 1.9.6 as described on the previous page. Some messages may be displayed with one or more symbols. The following table shows the fault message and symbols displayed for each fault condition.

	Message	Symbols Displayed	Fault Description
0			Traction operational and OK.
1			Only displayed briefly at power up.
2	BRUSH WEAR		Traction, Pump or Power Steer brushes worn.
3	BDI CUT OUT		BDI enabled and cut-out action initiated.
4	TRAC HOT	 & 	Traction heatsink above 75°C. Allow controller to cool.
5	ACCEL FAULT		Accelerator wire off. Recycle FS1 and Direction.
6	ACCEL FAULT		Accelerator pedal pressed at power up, or wire off. Recycle FS1 and Direction.

7	CONTACT FAULT		Contactors has bad contact or didn't close, motor o/c. Recycle FS1 & Dir.
8	CONTACT FAULT		Contactors didn't open or is welded. Recycle FS1 and Direction switch.
9	SEQ FAULT		Direction or FS1 switch at power up. Recycle Direction FS1 or both.
10	2 DIR FAULT		Two directions selected together. Recycle both Directions and FS1.
11	SRO FAULT		Dir. switch selected > 2 seconds after FS1. Recycle FS1 and Dir.
12	SEAT FAULT		Drive selected and no seat sw. Recycle Dir and FS1 switch
13	INCH FAULT		Inch switch at power up , both inch switches selected or inching attempted with seat switch or Dir/FS1 selected. Recycle inch switches.
14	BATTERY LOW		Battery < Low battery personality. Recycle FS1 or Direction switch
15	BATTERY HIGH		Battery > High battery personality. Recycle FS1 or Direction switch
16	PERS ERROR	 & 	Personalities out of range at power up.
17	CRC ERROR	 & 	One or more personalities have been corrupted.
18	COIL FAIL		A contactor coil s/c or miswired. Recycle Keyswitch
19	MOSFET FAIL	 & 	Bypass contactor s/c or MOSFET s/c Recycle FS1 or Direction
20		 & 	Traction motor too hot.
21		 & 	Pump motor too hot.
22	FAIL	 & 	If any of these message are displayed then the controller has failed one of its internal power up checks.

12.1 SEM CONTROLLER OPERATION

A Separately Excited Motor must be controlled in such a way that it gives the high starting torques, wide speed range, and responsive braking characteristics associated with standard Series Motors. In addition it should also offer contactorless direction change, good speed/load regulation and inherent regenerative braking.

To achieve this the control system is capable of independently varying the applied motor Armature voltage and therefore Armature current, and independently varying the applied motor Field voltage and therefore Field current. Armature current and field current will both be measured using shunts.

The Field is controlled using a full bridge (4 quadrant) to provide solid state direction control as well as vary the applied voltage, whilst the Armature is controlled via a half bridge (2 quadrant) so that smooth, responsive braking can be achieved down to zero speed. A relationship defined by 3 pairs of personalities in the motor setup menu sets the target value of Field current at any given Armature current. By measuring the field resistance continuously during operation, the controller can achieve the target current despite changes in field resistance due to motor heating

A simple drive sequence is described below to outline the 2 main drive modes of Motor braking above and below Base speed. To understand these regions if we assume full accelerator is demanded in the forward direction, the drive sequence would be:-

1. Select the Field bridge to the forward direction and ramp up the Field voltage with minimum acceleration delay (100ms). Ensure the Field current limit is not exceeded.
2. At the same time as the Field voltage starts ramping up, commence ramping up the Armature voltage at the rate determined by the acceleration delay setting. Monitor Armature current to ensure it does not exceed the armature current limit setting. This stage is called the “Constant torque” region and will show good speed/load regulation of between approximately 5-10%.
3. The field current and armature current are controlled in an interrelated way which provides the desired level of torque, Torque Mode, or speed in, Speed Control Mode, in response to the accelerator demand.

To describe braking if we now assume the accelerator is gradually released and then fully released to initiate neutral braking then the following sequence of events will occur:-

4. At the start of braking, the field voltage is ramped up to maximum supply maximum current through the field. The armature voltage is controlled by pulsing the top armature MOSFET bridge to achieve the desired braking current through the motor armature. This continues until the vehicle has reached the exit condition described by the Regen Threshold and Delay personalities.

During the braking phase, if the Armature current exceeds the braking current limit setting, the Armature Voltage will be reduced. If the Armature Voltage is reduced to 0V and the current is exceeds the braking level, the Field voltage will be reduced until the braking Armature current reduces.

5. If at any stage the vehicle direction switch is changed from forward to reverse the above braking sequences will also apply, depending on what drive region was in operation at the time. Once the vehicle has braked to a halt the Field bridge will be selected to reverse the current flow in the Field and drive will commence as described above in the new direction.

12.2 SPEED CONTROL

The PowerpaK and MicropaK controllers both have sensorless closed loop speed control functionality. This section briefly describes the principles behind closed loop speed control and give guidelines on how best to set up the speed control function.

12.2.1 Closed Loop Speed Control

The system does not require a speed encoder, instead it estimates the speed by measuring field and armature current. The speed is displayed, in KPH, in the status menu. For Dual Motor systems, the speed of both the left and right hand motors is displayed.

Sevcon's standard closed loop speed control algorithm uses a PI (Proportional – Integral) algorithm to control the speed to the required level. The required speed is set by the accelerator demand and can be limited by cutback speeds or personalities such as Speed Limit. In Speed Control mode, the system ramps the speed demand using the Acceleration and Deceleration Delay personalities to the required speed and the armature voltage is ramped at the fastest possible rate. This is different to Torque mode, where it is the armature voltage which is ramped using the Acceleration and Deceleration Delay personalities. The field voltage is set using the motor setup tables described earlier.

When the speed is below the speed demand, the system increases torque to the motor to increase the speed. As the speed approaches the speed demand, the system begins to reduce the rate of increase of torque until the speed demand is reached. If the speed increases above the speed demand, the system begins to reduce the torque to the motor until the speed demand is reached again. If the speed continues to increase, the system goes into an overspeed braking mode and regen braking is applied. This continues until the speed drops below the speed demand, at which point the system re-enters drive.

If the system has been set up correctly, it should never enter regen braking whilst driving on the flat or up an incline and it should quickly enter regen braking when driving down an incline and remain in braking until the bottom is reached, at which point drive is re-entered.

Neutral and Direction Braking in Speed Control mode are functions of time, rather than a fixed level of current, as is usual in Torque mode. When neutral is selected or the accelerator demand is reduced, the speed demand is ramped down at the Deceleration Delay personality. The system will enter regen braking to reduce the speed as the speed demand ramps down. Obviously, a short Deceleration Delay will cause a lot of braking effort to be applied to slow the vehicle and a longer delay will apply less braking effort. Direction braking works in the same way, but the speed demand is ramped down at the Direction Regen Time personality.

The following example demonstrates how Speed Control works:

- 1. From a standstill, the operator applies 50% accelerator demand.**
The speed demand begins to ramp to 50% at the Acceleration Delay, and the system applies a torque to the motor to reach the required speed. As the speed approaches the speed demand the rate of rise of torque is reduced, until the desired speed is reached. The system controls the torque to maintain the speed.
- 2. The vehicle begins to drive up an incline.**
The system detects the reduction in speed and increases the torque to the motor to maintain the required speed.
- 3. The vehicle reaches the top of the incline and is driving on the flat again.**
The system detects an increase in speed and decreases the torque to the motor to maintain the required speed. The system should not have to enter regen braking to reduce the speed here.
- 4. The vehicle begins to drive down an incline**
The system detects an increase in speed and begins to decrease the torque to the motor. The speed continues to increase, so the system enters regen braking to reduce the speed further. The system remains in regen braking until the vehicle reaches the bottom of the incline. The system should not exit braking and re-enter drive, whilst travelling down the incline.

5. **The vehicle reaches the bottom of the incline.**
The system detects the reduction in speed and decreases the braking level the motor. The speed continues to decrease, so the system re-enters drive and applies torque to the motor to reach the required speed.
6. **The operator selects the opposite direction to initiate direction braking.**
The system ramps the speed demand down to 0 at the Direction Regen Time personality. The speed control algorithm enters regen braking to maintain the speed to the speed demand as it ramps down. Once the vehicle has stopped, the system re-enters drive and ramps the speed demand to the Accelerator demand at the Acceleration Delay. The speed control algorithm applies a torque to the motor to reach the required speed.
7. **The operator selects neutral.**
The system ramps the speed demand down to 0 at the Deceleration Delay personality. The speed control algorithm enters regen braking to maintain the speed to the speed demand as it ramps down to 0. Once the vehicle has stopped, the system enters neutral.

12.2.2 Setting up Speed Control

Closed loop speed control, requires the system to be setup very carefully. Many factors can affect how well speed control operates. To be able to effectively set up Speed Control mode, the vehicle must first be operating satisfactorily in Torque mode. Take care to ensure that the Motor Setup tables are set up correctly.

The following sections describes how best to configure the system for optimal performance.

12.2.2.1 Speed Estimate

As already mentioned, speed is displayed as a KPH value in the Status menu. In actual fact, the speed is stored internally as a percentage value, where 100% is the fastest unladen vehicle speed. The KPH value is derived by measuring the fastest unladen speed of the vehicle in KPH and entering this value in the Full Speed setup item in the Setup menu. For example, if the full unladen speed of the vehicle is 8.0KPH and the current vehicle speed is 50%, the system will display 4.0KPH in the status menu.

The following personalities and setup items must be set correctly for speed estimation to be accurate:

1. **Field Resistance (1.7.8).** The motor field resistance accurate to the nearest 0.01Ω should be entered here. This item needs to be entered correctly for the field to be controlled accurately. This is important in any mode of operation (Torque or Speed).
2. **Armature Resistance (1.7.7).** The motor armature resistance accurate to the nearest milliohm should be entered here.
3. **Full Speed (1.6.24).** This ensures that the speed displayed in the Status menu and on Dashboard displays is accurate.
4. **Armature Current Low (1.7.1) and Field Current Low (1.7.2).** These items determine the maximum speed of the unladen vehicle. If one of these items is changed, then the maximum speed of the vehicle might have changed and so the Full Speed setup item will need to be modified appropriately.

12.2.2.2 Speed Control Algorithm

The system uses a PI algorithm for Speed Control. As with all PI algorithms, there are proportional and integral gains which need to be setup correctly. The following diagram illustrates the affect of proportional and integral gains on a standard PI control loop.

PI Control Algorithm

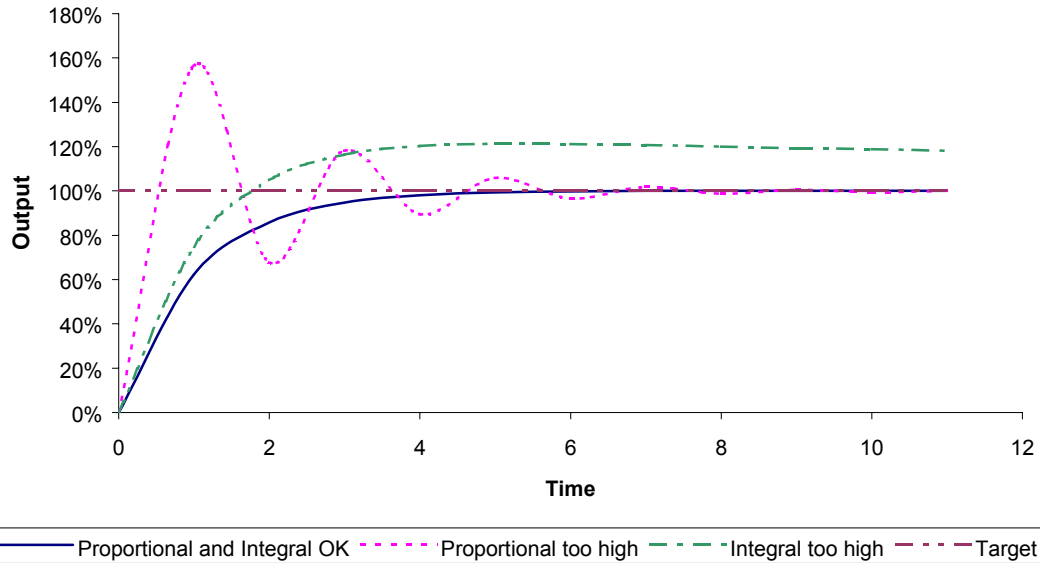

As can be seen, too much proportional gain can cause large over-shoot and poor control to occur from the PI Control Loop and too much integral gain can cause the speed to over-shoot and take a long time to get back to the required output.

The following section describes the personalities and gives some guidelines on how to set up the PI Control Loops.

12.2.2.2.1 Personalities

The system uses separate algorithms for drive and braking and hence different gains are required.

1. **Speed Proportional (1.1.35).** Proportional gain for speed control during drive. Has a maximum value of 127.
2. **Brake Proportional (1.1.36).** Proportional gain for speed control during regen braking. Has a maximum value of 127.
3. **Speed Integral (1.1.37).** Integral gain for speed control during drive. Has a maximum value of 16.
4. **Brake Integral (1.1.38).** Integral gain for speed control during regen braking. Has a maximum value of 16.

12.2.2.2.1 Guidelines

To set up the drive proportional and integral gains use the following guidelines:

1. Set the drive proportional and integral terms to 0. Increase the proportional term slightly. The vehicle will drive very slowly but the control will be smooth. Increase the drive proportional until the vehicle control is no longer smooth. Once this happens reduce the drive proportional value to the point at which the control became unstable. Set the drive proportional to half this value. The vehicle control will now be smooth, but it will not reach the required speed. This is where the drive integral gain comes into use.
2. Increase the drive integral gain to a point where the vehicle can easily reach the required speed in a time equal to the Acceleration Delay. Ensure that the integral term is not set too high, otherwise the vehicle speed will over-shoot and braking may occur.

To set up the brake proportional and integral gains use the following guidelines:

1. It is best to setup the braking proportional and integral gains on an incline, but beware that the vehicle will not speed control properly until the gains have been set correctly.

- Set the brake proportional and integral terms to 0. Increase the proportional term slightly. The vehicle will brake at a level too low to keep the speed at that required, but the braking control will be smooth. Increase the brake proportional until the vehicle starts brake very aggressively and the control is unstable. Once this happens reduce the brake proportional value to the point at which the control became unstable. Set the brake proportional to half this value.
2. Increase the brake integral gain to a point where the system can easily supply enough braking to keep the reach vehicle at the required speed. If the brake integral gain is too high the vehicle will continually brake to a stop on the incline.

Once the speed control is set up satisfactorily, set the Deceleration Delay personality to give the required level of braking when neutral is selected and set the Direction Regen Time personality to give the required level of braking when a direction change occurs.

As a guide, the following table show sample values for a range of vehicles.

Vehicle Type	Speed Values		Brake Values	
	Proportional	Integral	Proportional	Integral
800kg Walkie	14	2	30	3
3000kg Counter Balance	20	2	30	2
6000kg Counter Balance	100	4	100	6

12.3 POWER CIRCUIT DESCRIPTIONS

The main Armature drive switching element of the PowerpaK SEM variant consists of paralleled power Mosfet transistors, switched at high frequency during drive (16 KHz). Switching speeds have been optimised to minimise switching losses. SOA's cut back the current at high % ons to ensure the Mosfet junctions are not stressed.

Additional Armature braking Mosfets are connected in parallel with the Armature, and switched at high frequency to regeneratively brake the motor below base speed. Regen is automatic above base speed when the Field current is increased or when Field current is constant and the motor speeds up by encountering a downward slope for example.

The intrinsic diodes in the Mosfets are used to maintain circulating current around the motor when the main Mosfets are turned off, to prevent excessive voltage transients and maintain motor torque. SOA's are used at low % ons to limit the maximum current to ensure the diode junction temperatures are not stressed.

Both sets of Drive and Brake Mosfets have their temperatures monitored, to prevent excessive junction temperatures.

Electrolytic capacitors are fitted internally between B+ve and B-ve to maintain constant current in the battery leads and to keep a constant battery voltage across the controller.

A current shunt is connected in series with the motor armature to monitor motor currents, during all operations including drive and regen braking modes. A separate current shunt is used to measure field current.

Motor direction change is achieved by reversing Field current flow with the Field bridge.

A line contactor should be specified to offer reverse battery connection protection, and minimise any battery connector arcing when powering up.

Bypass operation is available as an option to short out the main Armature drive Mosfet devices for maximum efficiency and high speed or high current operation.

13 INSTALLATION

- 13.1 The controller should be bolted down to a flat (0.2mm max. deviation) paint free surface that has been lightly coated with a thermal transfer compound, such as G641 or Dow Corning heatsink compound, by the 4 fixing holes provided. Care should be taken not to trap any wires, etc., under the controller. **The mounting surface MUST be a substantial metal section of the truck for the full controller ratings to be achieved. In arduous applications additional aluminium heatsinking maybe required to obtain acceptable thermal performance.**
- 13.2 Power connections should be made with flexible heat resisting cables of suitable cross-sectional area for the current to be carried. These should be terminated in soldered or crimped lugs attached to controller and the contactors. Note that nuts and washers are supplied for the M8 connections on the controller. A battery-disconnect switch should be used (EC Directive).
- 13.3 The contactor mounting plane can affect performance, contactors should never be mounted with their terminal studs vertically down. For further applications information on contactors, please consult SEVCON.
- 13.4 The controller may be supplied as a stand-alone unit or pre-wired onto a base-plate with contactors etc. The mating halves of the light wiring connectors can be supplied with the controller as a 'loose equipment kit'.
- 13.5 Control wiring connections should be made using 1.00mm² (AWG#18) or equivalent stranded wire. The correct pressure release crimping tools MUST be used for long term connection reliability.
- 13.6 The main battery cable should be fused with a suitable air-break fuse. The keyswitch line must also be fused at a level not exceeding 10 A when using the specified Albright contactors.
- 13.7 The return wiring for the accelerators should be connected to the B- terminal on the controller to prevent large currents altering accelerator signals.
- 13.8 Fixing torque for power connectors
- | | |
|--------------|----------------------|
| M8 terminals | 11Nm +0.5Nm, -0.2Nm |
| M6 terminals | 4.5Nm +0.5Nm, -0.2Nm |
- 13.9 When installing a controller for the first time in a new application, ensure that the field resistance personality (menu item 1.7.8) is set to the correct field resistance value, at 25°C, for the motor field.

The following guidelines are intended to help vehicle manufacturers to meet the requirements of the EC directive 89/336/EEC for Electromagnetic Compatibility.

Any high speed switch is capable of generating harmonics at frequencies that are many multiples of its basic operating frequency. It is the objective of a good installation to contain or absorb the resultant emissions.

All wiring is capable of acting as a receiving or transmitting antenna. Wiring should be arranged to take maximum advantage of the structural metal work inherent in most vehicles. Vehicle metalwork should be electrically linked with conductive braids.

14.1 Power Cables

All cables should be routed within the vehicle framework and kept as low in the structure as is practical - a cable run within a main chassis member is better screened from the environment than one routed through or adjacent to an overhead guard.

Power cables should be kept short to minimise emitting and receiving surfaces

Shielding by the structure may not always be sufficient - cables run through metal shrouds may be required to contain emissions.

Parallel runs of cables in common circuits can serve to cancel emissions - the battery positive and negative cables following similar paths is an example.

Tie all cables into a fixed layout and do not deviate from the approved layout in production vehicles. A re-routed battery cable could negate any approvals obtained.

14.2 Signal Cables

All wiring harnesses should be kept short.

Wiring should be routed close to vehicle metalwork.

All signal wires should be kept clear of power cables or made from screened cable

Control wiring should be kept clear of power cables when it carries analogue information - for example, accelerator wiring.

Tie all wiring securely and ensure wiring always follows the same layout.

14.3 Controller

Thermal and EMC (emissive) requirements tend to be in opposition.

Additional insulation between the controller assembly and the vehicle frame work reduce capacitive coupling and hence emissions but tend to reduce thermal ratings. A working balance needs to be established by experiment.

The complete installation should be documented, in detail, and faithfully reproduced on all production vehicles. When making changes, consider their effect on compliance ahead of any consideration of cost reduction or other "improvement".

STANDARD SEVCON POWER UP, SEAT SWITCH AND SRO SEQUENCING DESCRIPTION

KEY SWITCH POWER UP TRUTH TABLE (NO SRO ENABLED)						
	Key Sw.	Seat Sw.	Direction Sw.	FS1 Sw.	Drive	Fault Indicated
1-8	0	X	x	x	No	None
9	1	0	0	0	No	None
10	1	0	0	1	No	None
11	1	0	1	0	No	None
12	1	0	1	1	No	Seat Fault
13	1	1	0	0	No	None
14	1	1	0	1	No	None
15	1	1	1	0	No	None
16	1	1	1	1	Yes	None
KEY SWITCH POWER UP SEQUENCE TABLE (NO SRO ENABLED)						
1	Key	Seat	Direction	FS1	Yes	None
2	Key	Seat	FS1	Direction	Yes	None
3	Key	Direction	Seat	FS1	No	Seat Fault
4	Key	Direction	FS1	Seat	No	Seat Fault
5	Key	FS1	Seat	Direction	No	Seat Fault
6	Key	FS1	Direction	Seat	No	Seat Fault
7	Seat	Key	Direction	FS1	Yes	None
8	Seat	Key	FS1	Direction	Yes	None
9	Seat	Direction	Key	FS1	No	Power Up Fault
10	Seat	Direction	FS1	Key	No	Power Up Fault
11	Seat	FS1	Key	Direction	No	Power Up Fault
12	Seat	FS1	Direction	Key	No	Power Up Fault
13	Direction	Key	Seat	FS1	No	Power Up Fault
14	Direction	Key	FS1	Seat	No	Power Up Fault
15	Direction	Seat	Key	FS1	No	Power Up Fault
16	Direction	Seat	FS1	Key	No	Power Up Fault
17	Direction	FS1	Key	Seat	No	Power Up Fault
18	Direction	FS1	Seat	Key	No	Power Up Fault
19	FS1	Key	Seat	Direction	No	Power Up Fault
20	FS1	Key	Direction	Seat	No	Power Up Fault
21	FS1	Seat	Key	Direction	No	Power Up Fault
22	FS1	Seat	Direction	Key	No	Power Up Fault
23	FS1	Direction	Key	Seat	No	Power Up Fault
24	FS1	Direction	Seat	Key	No	Power Up Fault

SEAT SWITCH TRUTH TABLE (NO SRO ENABLED)						
	Seat Sw.	Seat Timer	Direction Sw.	FS1 Sw.	Drive	Fault Indicated
1	0	0	0	0	No	No
2	0	0	0	1	No	No
3	0	0	1	0	No	Seat Fault
4	0	0	1	1	No	Seat Fault
5	0	1	0	0	No	No
6	0	1	0	1	No	No
7	0	1	1	0	No	No
8	0	1	1	1	Yes	No
9	1	X	0	0	No	No
10	1	X	0	1	No	No
11	1	X	1	0	No	No
12	1	X	1	1	Yes	No
13	1	X	0	0	No	No
14	1	X	0	1	No	No
15	1	X	1	0	No	No
16	1	X	1	1	Yes	No
SEAT SWITCH SEQUENCE TABLE (NO SRO ENABLED)						
1	Seat	Direction	FS1		Yes	No
2	Seat	FS1	Direction		Yes	No
3	Direction	Seat	FS1		No	Seat Fault
4	Direction	FS1	Seat		No	Seat Fault
5	FS1	Seat	Direction		No	Seat Fault
6	FS1	Direction	Seat		No	Seat Fault

SRO (Static Return to Off) TRUTH TABLE						
	Direction Sw.	FS1 Sw.			Drive	Fault Indicated
1	0	0			No	None
2	0	1			No	None
3	1	0			No	None
4	1	1			Yes	None
SRO (Static Return to Off) SEQUENCE TABLE						
1	Direction	FS1			Yes	None
2	FS1	Direction within 2 seconds			Yes	None
3	FS1	Direction after 2 seconds			No	SRO FAULT

Graph 1 - Accelerator Characteristics

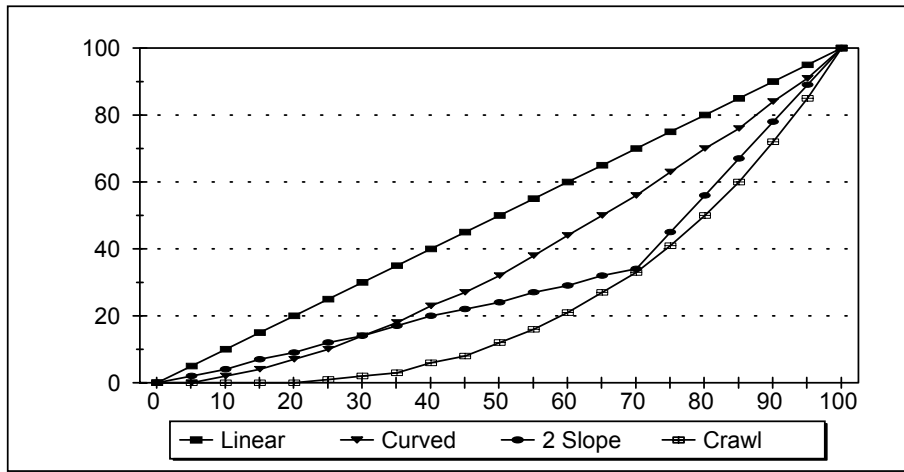

Graph 2 - Thermal Cutback Characteristic

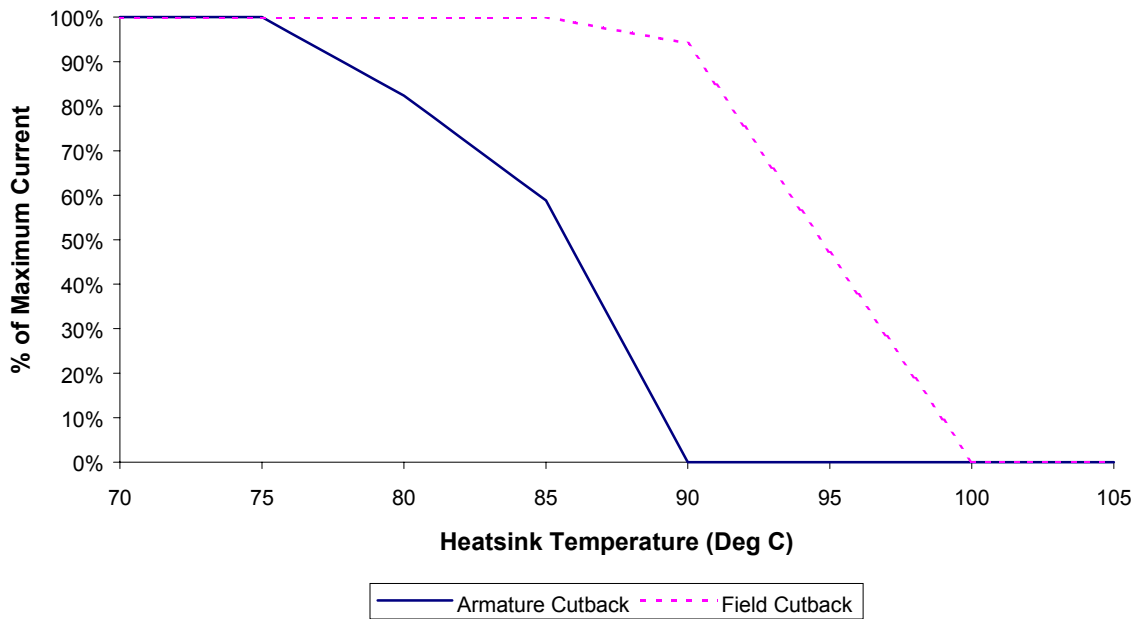

Graph 3 - Safe Operating Area Graphs

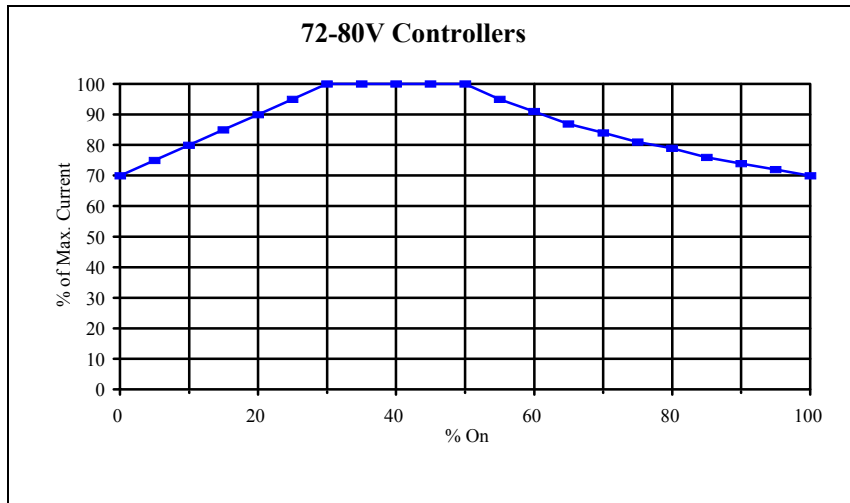
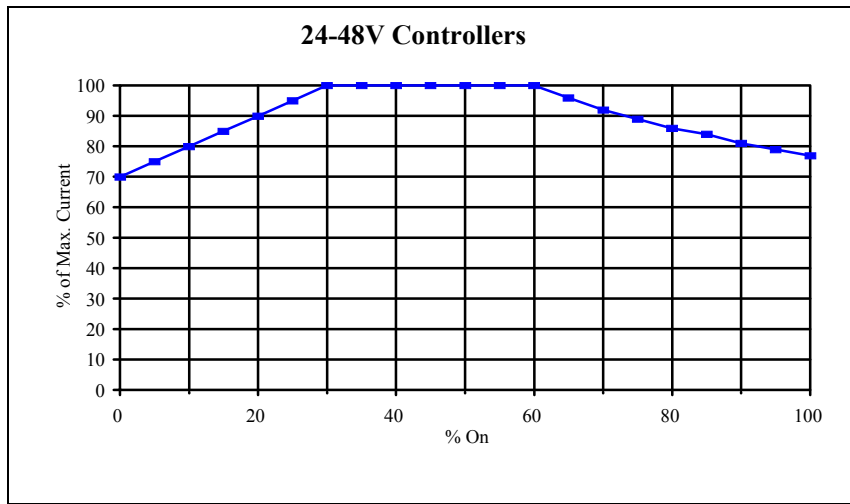

Figure 1 Light Wiring - MicropaK

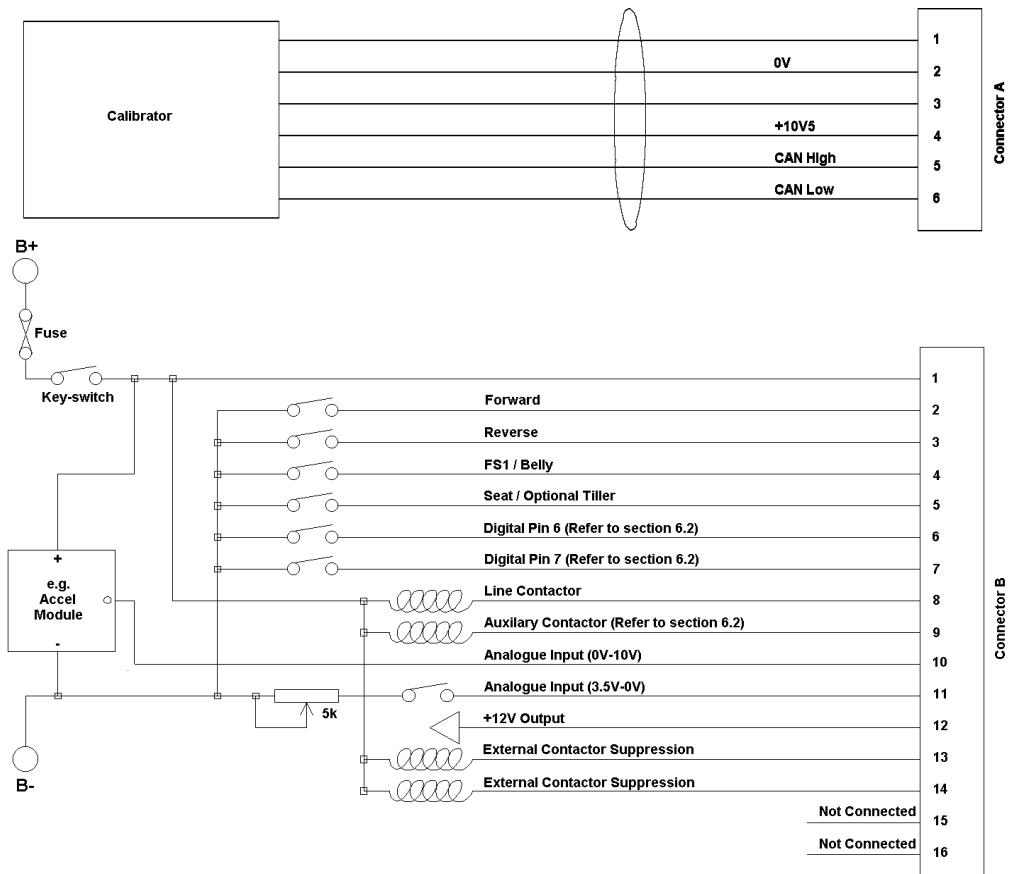
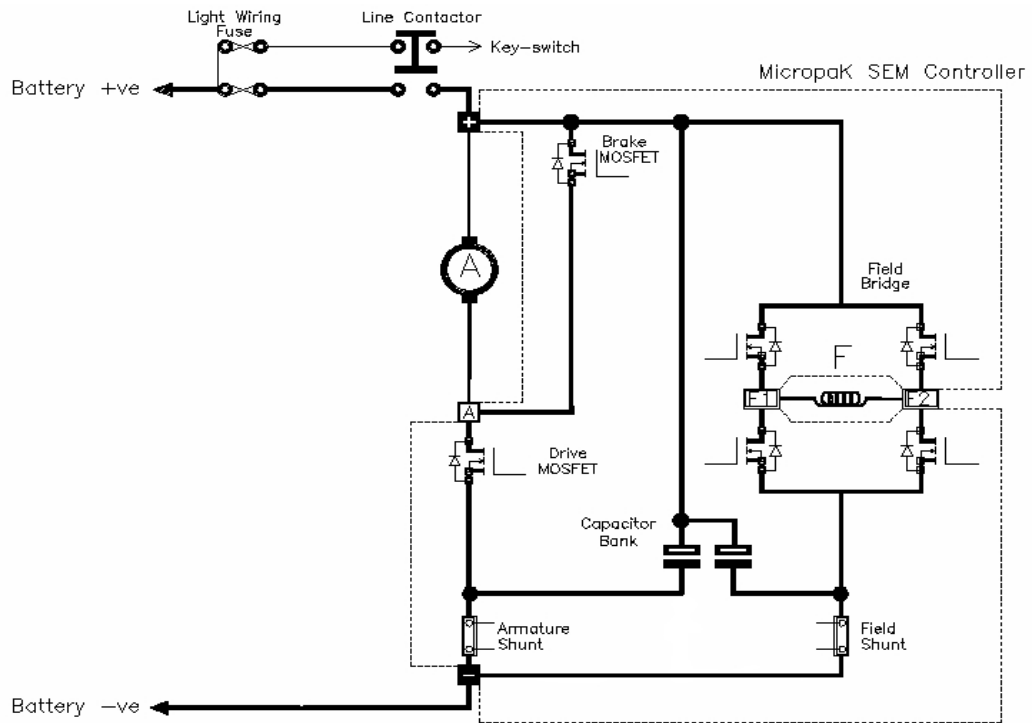

Figure 2 Power Wiring - MicropaK



NOTE: When an emergency battery disconnect switch is fitted, the key switch must be fed through an auxiliary switch to prevent overvoltage damage due to disconnection during regen.

Figure 3 Light Wiring - PowerpaK

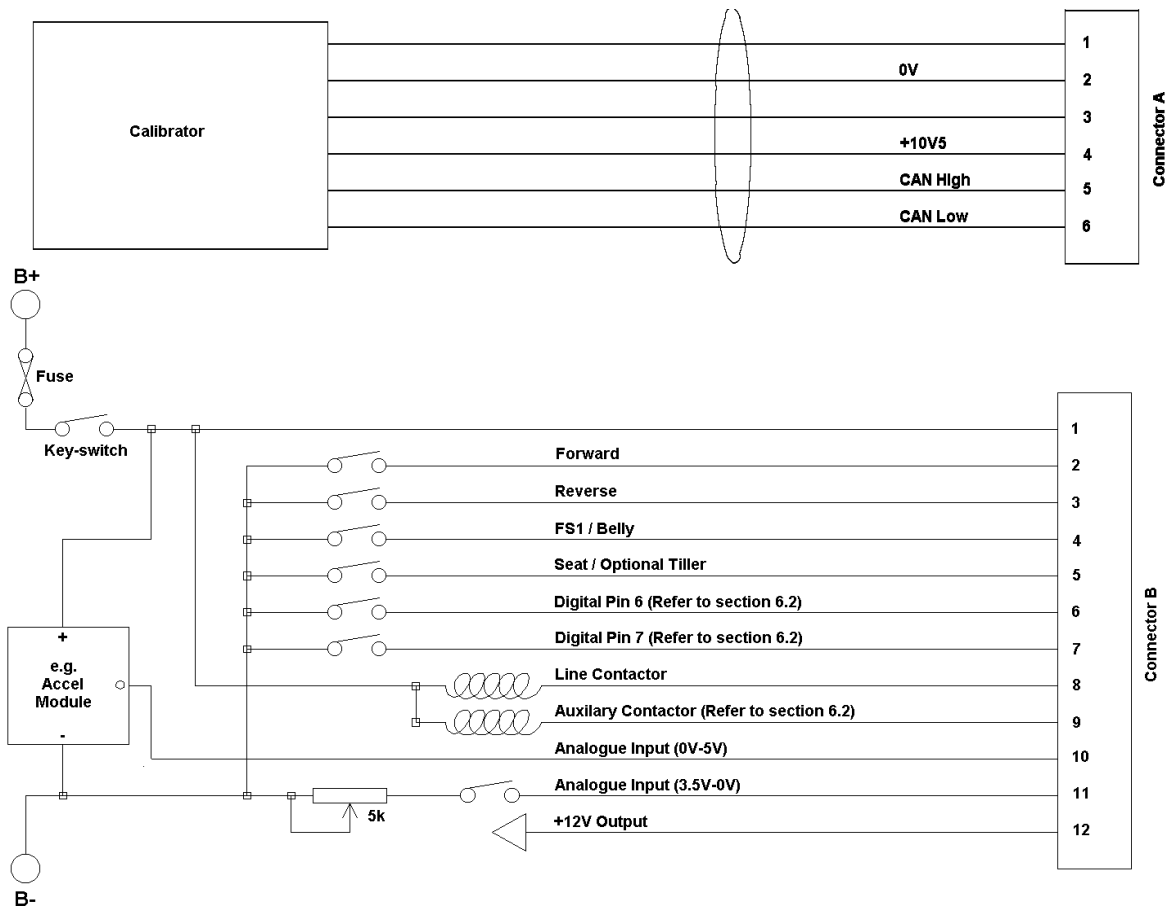
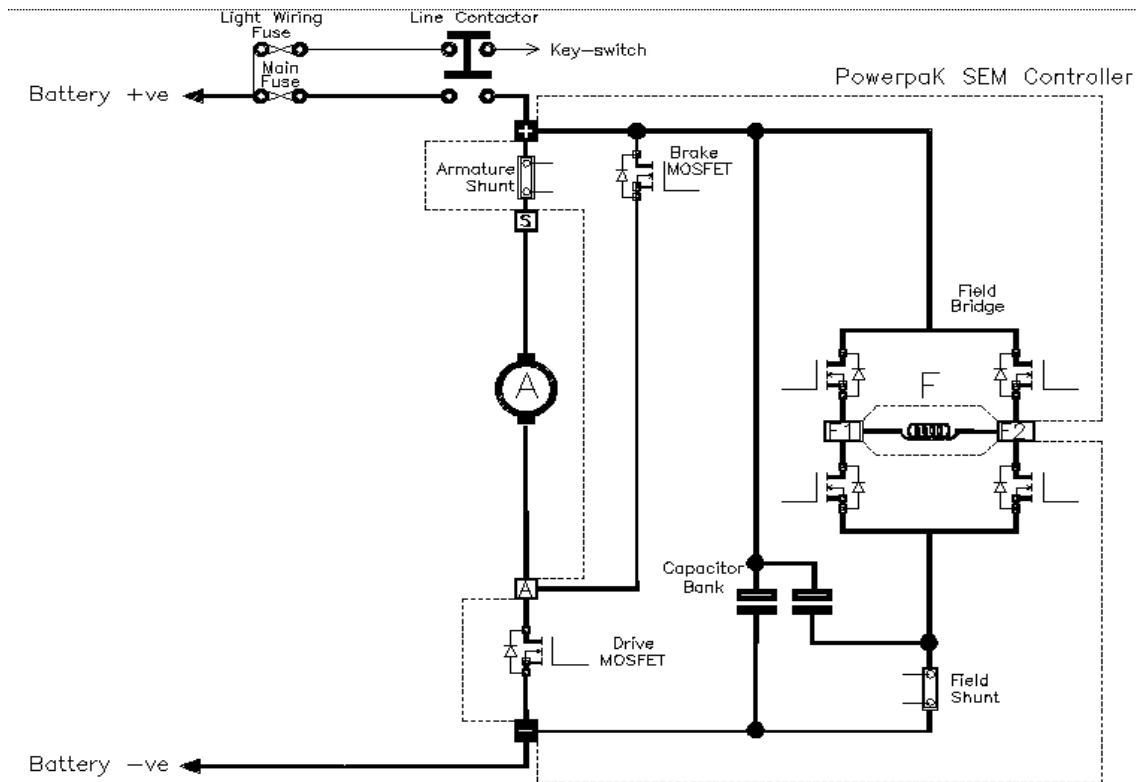

Figure 4 Power Wiring – PowerpaK



NOTE: When an emergency battery disconnect switch is fitted, the key switch must be fed through an auxiliary switch to prevent overvoltage damage due to disconnection during regen.

Figure 5 PowerpaK SEM Dual Motor - CAN Master / Slave Arrangement

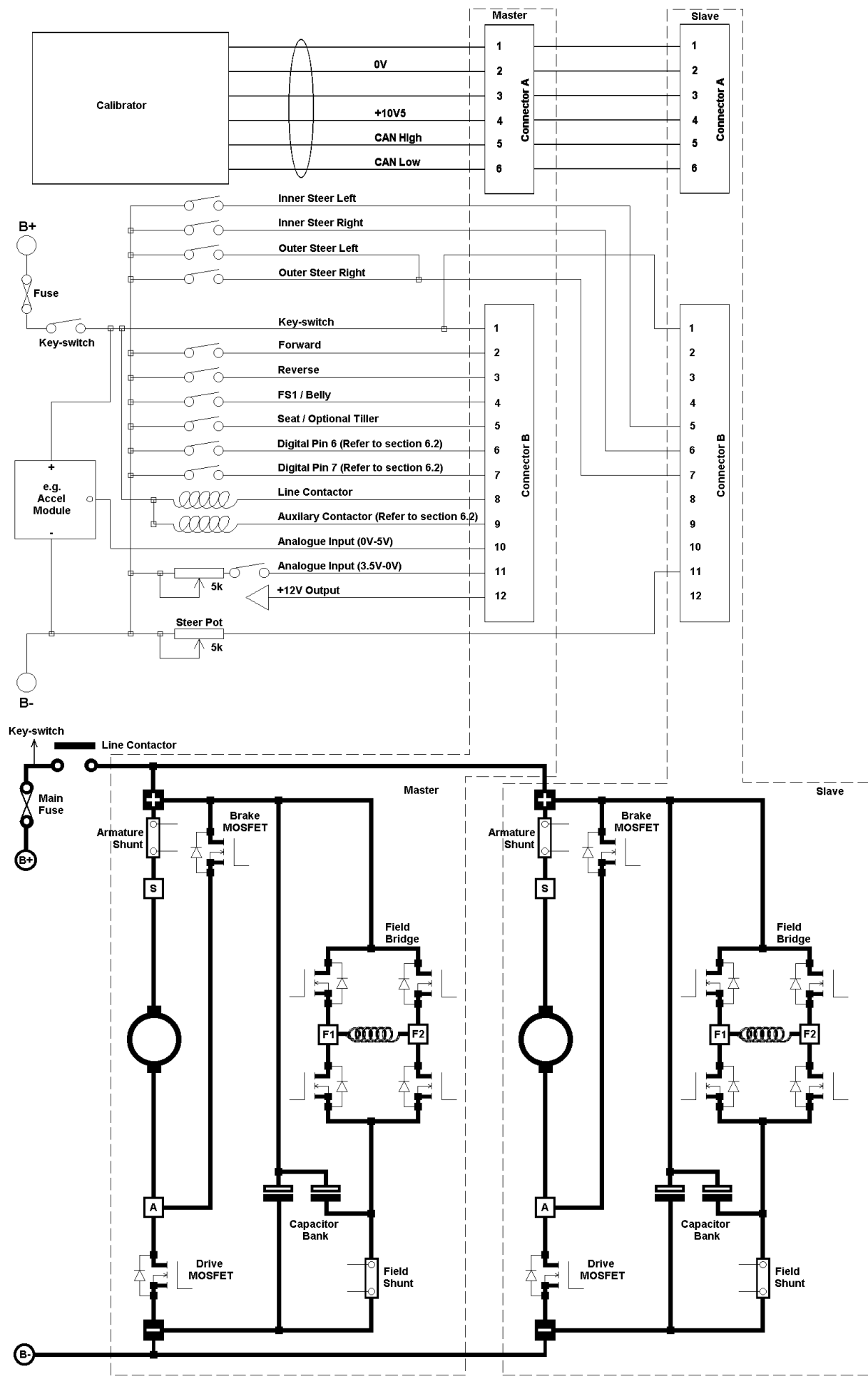

Figure 6 Mechanical Details - PowerpaK

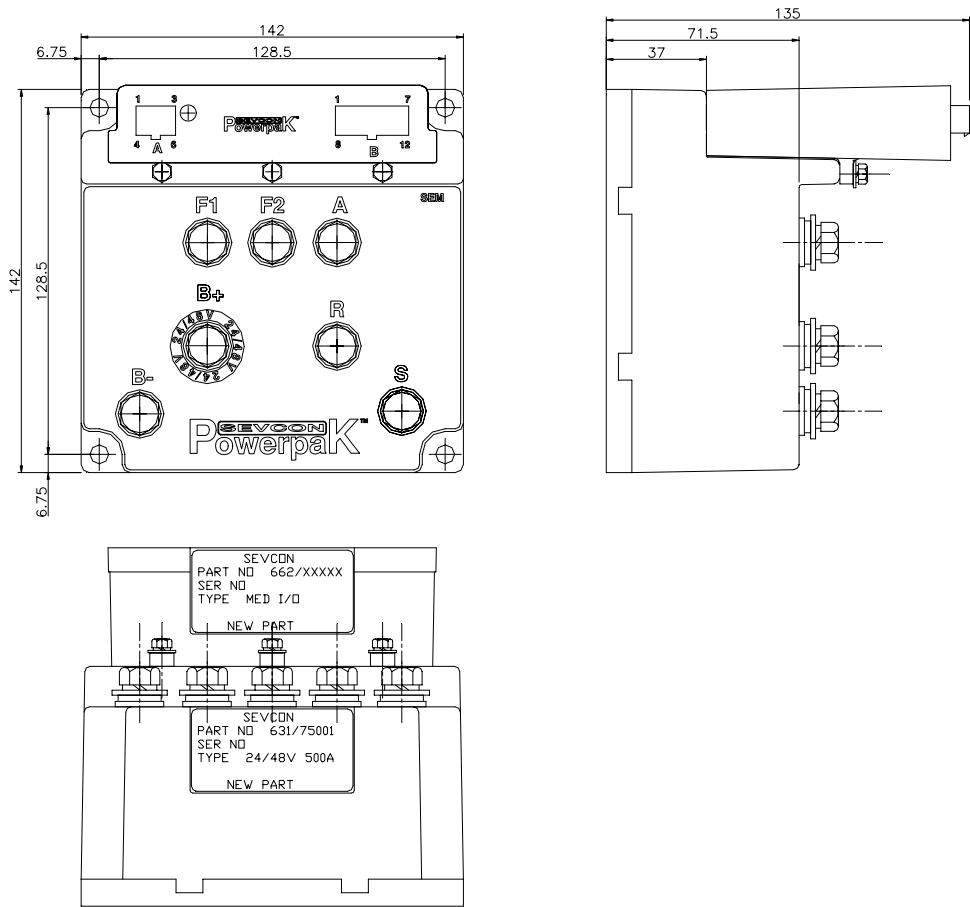
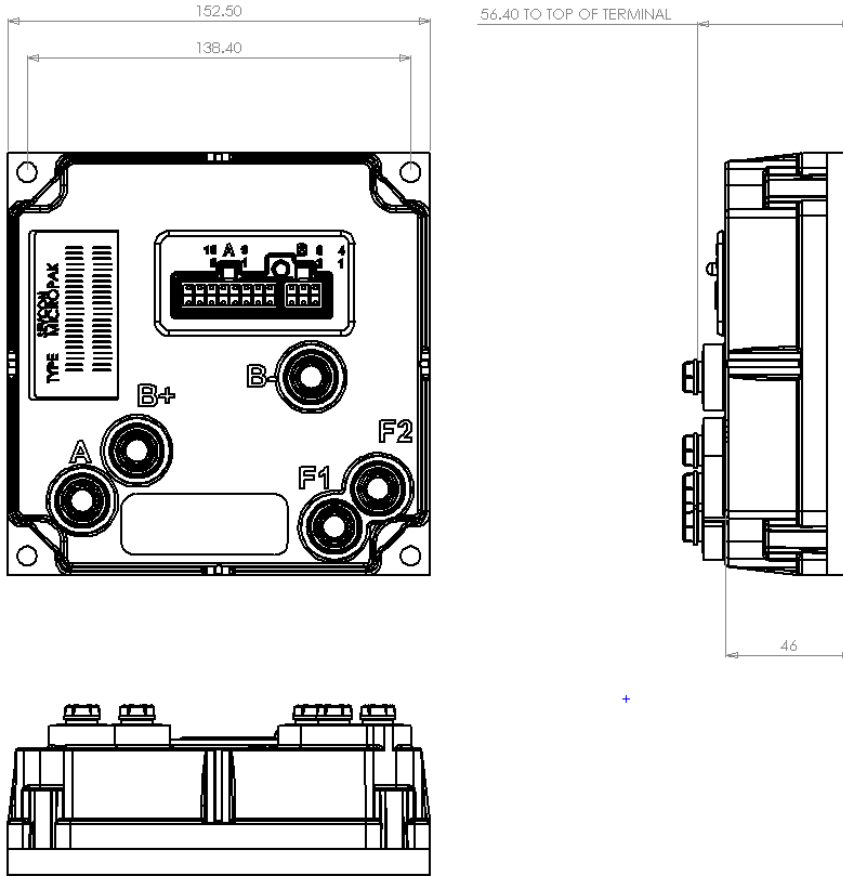

Figure 7 Mechanical Details - MicropaK

NB: Mounting holes are for M6 bolts.



Appendix A – MicropaK and PowerpaK Traction SEM Configuration I/O Specification

Introduction

In order to reduce complexity of the way hardware I/O is configured on a Traction SEM system, all the Calibrator items which allow the operator to setup the Digital Switch inputs, Analogue inputs and Contactor Drives are to be replaced by two personalities:

- **Digital I/O.** This is a number which is used to specify what every digital switch input and contactor drive in the system is configured as. E.g. Forward Switch, Line Contactor, etc.
- **Analogue Inputs.** This is a number which is used to specify what every analogue input in the system is configured as. E.g. Accelerator, Footbrake Pot, etc.

Note: On systems with more than one node, e.g. Traction and Pump, Dual Traction, etc, these two personalities are set only on the Master Node and they determine the configuration for the entire system.

The I/O configured for particular values of the Digital I/O and the Analogue Inputs personalities depends on the type of system. For example, setting Digital I/O to 1 for a Standalone Traction System has a different effect to setting Digital I/O to 1 for a Dual Traction system. The following sections describe what the values of these personalities mean for each system setup.

General Notes

1. The numbering in the tables refer to the pin number on the customer connector for a specific controller. The Controller is identified by the first character. These have the meaning:
 - T = Traction. (Single Traction systems)
 - P = Pump
 - M = Master Traction (Dual Traction systems)
 - S = Slave Traction (Dual Traction systems)

For example, T-B2 is pin 2 on connector B on a Single Traction, S-B9 is pin 9 on a Slave Traction Controller.
2. Analogue inputs can be configured as Digital inputs. In the tables, ‘AD’ refers to a digital input which would be read via an Analogue Input if an appropriate Analogue input is configured as Digital. At present, only one analogue input in a system can be configured as a Digital.

Standalone / Master Traction Only

There is very little difference between a Controller setup as Standalone and one setup as a Master but has no other nodes (e.g. Pump) associated. The only real difference is the Traction Controller configured as a Master can communicate with a CANbus display. Their configurations will be treat as being identical, since the available I/O is the same on each.

I/O summary:

The Standalone / Master Traction Only system has the following I/O capability:

- Traction Controller (x1)
 - 6 Digital Switch Inputs
 - 2 Analogue Inputs
 - 2 Contactor Drive outputs

Digital I/O Personality:

Digital Function	Value of Digital I/O Configuration Item												
	1	2	3	4	5	6	7	8	9	10	11	12	13
Forward	T-B2	T-B2	T-B2	T-B2	T-B2	T-B2	T-B2	T-B2	T-B2	T-B2	T-B2	T-B2	T-B2
Reverse	T-B3	T-B3	T-B3	T-B3	T-B3	T-B3	T-B3	T-B3	T-B3	T-B3	T-B3	T-B3	T-B3
Belly	T-B4	T-B4	T-B4	T-B4									
Tiller	T-B5	T-B5	T-B5										
FS1					T-B4	T-B4	T-B4	T-B4	T-B4	T-B4	T-B4	T-B4	T-B4
Seat					T-B5	T-B5	T-B5	T-B5	T-B5	T-B5	T-B5	T-B5	T-B5
Speed Cutback 1	T-B6	T-B6	T-B6	T-B6			T-B6	T-B6		AD	AD	T-B6	T-B6
Speed Cutback 2													T-B7
Speed Cutback 3	AD			T-B5			AD						
Inch Forward					T-B6	T-B6							
Inch Reverse					T-B7	T-B7							
Handbrake					AD		T-B7	T-B7	T-B7	T-B7	T-B7		
Power Steer Trigger						AD		AD	T-B6				AD
Pump Trigger	T-B7		T-B7	T-B7							T-B6	T-B7	
Constant Speed		AD	AD	AD									
Brake Override Switch		T-B7											
Footbrake Switch									AD	T-B6		AD	
Line Contactor	T-B8	T-B8	T-B8	T-B8	T-B8	T-B8	T-B8	T-B8	T-B8	T-B8	T-B8	T-B8	T-B8
Power Steer Contactor					T-B9	T-B9	T-B9	T-B9	T-B9	T-B9			T-B9
Pump Contactor	T-B9		T-B9	T-B9							T-B9	T-B9	
Electromagnetic Brake		T-B9											

Table 1. Digital Functions for Standalone / Master Traction

Notes:

- Any configuration which contains a Belly switch configuration is assumed to be a Walkie type vehicle. All other configurations are Ride-Ons. Only Standalone / Master Traction can be configured as a Walkie style vehicle.

Analogue Inputs Personality:

Analogue Function	Value of Analogue Input Configuration Item					
	1	2	3	4	5	6
Accelerator	T-B10	T-B11	T-B10	T-B11	T-B10	T-B11
Footbrake	T-B11	T-B10				
Economy			T-B11	T-B10		
Digital (AD)					T-B11	T-B10

Table 2. Analogue Functions for Standalone / Master Traction

Traction and Pump

I/O summary:

The Traction and Pump system has the following I/O capability:

- Traction Controller (x1)
 - 6 Digital Switch Inputs
 - 2 Analogue Inputs
 - 2 Contactor Drive outputs

- Pump Controller (x1)
 - 6 Digital Switch Inputs
 - 2 Analogue Inputs

Digital I/O Personality:

Digital Function	Value of Digital I/O Configuration Item								
	1	2	3	4	5	6	7	8	9
Forward	T-B2	T-B2	T-B2	T-B2	T-B2				
Reverse	T-B3	T-B3	T-B3	T-B3	T-B3				
FS1	T-B4	T-B4	T-B4	T-B4	T-B4				
Seat	T-B5	T-B5	T-B5	T-B5	T-B5				
Speed Cutback 1	T-B6	T-B6	AD	AD	AD				
Speed Cutback 2									
Speed Cutback 3	AD	AD							
Handbrake	T-B7	T-B7	T-B7	T-B7	T-B7				
Power Steer Trigger	P-B7		P-B7						
Footbrake Switch			T-B6	T-B6	T-B6				
Pump Switch 3	P-B2	P-B2	P-B2	P-B2	P-B2				
Pump Switch 4	P-B3	P-B3	P-B3	P-B3	P-B3				
Pump Switch 5	P-B4	P-B4	P-B4	P-B4	P-B4				
Pump Switch 6	P-B5	P-B5	P-B5	P-B5	P-B5				
Pump Switch 7	P-B6	P-B6	P-B6	P-B6	P-B6				
Pump Inhibit		P-B7		P-B7	P-B7				
Line Contactor	T-B8	T-B8	T-B8	T-B8	T-B8				
Power Steer Contactor	T-B9	T-B9	T-B9	T-B9					
External LED					T-B9				

Table 3. Digital Functions for Traction and Pump

Analogue Inputs Personality:

Analogue Function	Value of Analogue Input Configuration Item															
	1	2	3	4	5	6	7	8	9	10	11	12	13	14	15	16
Accelerator	T-B10	T-B11	T-B10	T-B11	T-B10	T-B11	T-B10	T-B11	T-B10	T-B11	T-B10	T-B11	T-B10	T-B11	T-B10	T-B11
Footbrake	T-B11	T-B10			T-B11	T-B10	T-B11	T-B10			T-B11	T-B10				
Economy			T-B11	T-B10					T-B11	T-B10						
Pump Lift Accelerator A	P-B10	P-B10	P-B10	P-B10	P-B10	P-B10	P-B11	P-B11	P-B11	P-B11	P-B11	P-B11	P-B10	P-B10	P-B11	P-B11
Pump Lift Accelerator B	P-B11	P-B11	P-B11	P-B11			P-B10	P-B10	P-B10	P-B10			P-B11	P-B11	P-B10	P-B10
Digital (AD)					P-B11	P-B11					P-B10	P-B10	T-B11	T-B10	T-B11	T-B10

Table 4. Analogue Functions for Traction and Pump

Dual Traction

I/O summary:

The Dual Traction system has the following I/O capability:

- Traction Controller (x2)
 - 12 Digital Switch Inputs
 - 4 Analogue Inputs
 - 4 Contactor Drive outputs

Digital I/O Personality:

Digital Function	Value of Digital I/O Configuration Item								
	1	2	3	4	5	6	7	8	9
Forward	M-B2	M-B2	M-B2	M-B2					
Reverse	M-B3	M-B3	M-B3	M-B3					
FS1	M-B4	M-B4	M-B4	M-B4					
Seat	M-B5	M-B5	M-B5	M-B5					
Speed Cutback 1	M-B6	M-B6							
Speed Cutback 2	S-B2								
Speed Cutback 3	S-B3	AD							
Handbrake	M-B7	M-B7	M-B7	M-B7					
Power Steer Trigger	S-B6	S-B6	S-B6	S-B6					
Footbrake Switch	S-B7	S-B7	S-B7	S-B7					
Inner Left Switch		S-B2		S-B2					
Inner Right Switch		S-B3		S-B3					
Outer Switch		S-B4		S-B4					
Pump Trigger	S-B5	S-B5	S-B5	S-B5					
Line Contactor	M-B8	M-B8	M-B8	M-B8					
Power Steer Contactor	M-B9	M-B9	M-B9	M-B9					
Pump Contactor	S-B8	S-B8	S-B8	S-B8					
External LED	S-B9	S-B9	S-B9	S-B9					

Table 5. Digital Functions for Dual Traction

Analogue Inputs Personality:

Analogue Function	Value of Analogue Input Configuration Item							
	1	2	3	4	5	6	7	8
Accelerator	M-B10	M-B11	M-B10	M-B11	M-B10	M-B11	M-B10	M-B11
Footbrake	M-B11	M-B10	M-B11	M-B10				
Economy	S-B10	S-B10	S-B10	S-B10	M-B11	M-B10	M-B11	M-B10
Steer Pot	S-B11	S-B11			S-B11	S-B11		

Digital (AD)			S-B11	S-B11			S-B11	S-B11
--------------	--	--	-------	-------	--	--	-------	-------

Table 6. Analogue Functions for Dual Traction

Notes:

1. There is no need for any configuration with both Steer Pot and Analogue as Digital. If there is a Steer Pot, then the Steer switches are not required and there is enough switch inputs to accommodate every switch.

Dual Traction and Pump

I/O summary:

The Dual Traction and Pump system has the following I/O capability:

- Traction Controller (x2)
 - 12 Digital Switch Inputs
 - 4 Analogue Inputs
 - 4 Contactor Drive outputs

- Pump Controller (x1)
 - 6 Digital Switch Inputs
 - 2 Analogue Inputs

Digital I/O Personality:

Digital Function	Value of Digital I/O Configuration Item								
	1	2	3	4	5	6	7	8	9
Forward	M-B2	M-B2	M-B2	M-B2	M-B2				
Reverse	M-B3	M-B3	M-B3	M-B3	M-B3				
FS1	M-B4	M-B4	M-B4	M-B4	M-B4				
Seat	M-B5	M-B5	M-B5	M-B5	M-B5				
Speed Cutback 1	M-B6	M-B6			M-B6				
Speed Cutback 2	S-B2								
Speed Cutback 3	S-B5	S-B5							
Handbrake	M-B7	M-B7	M-B7	M-B7	M-B7				
Power Steer Trigger	S-B6	S-B6	S-B6	S-B6	S-B6				
Footbrake Switch	S-B7	S-B7	S-B7	S-B7	S-B7				
Inner Left Switch		S-B2			S-B2				
Inner Right Switch		S-B3			S-B3				
Outer Switch		S-B4			S-B4				
Pump Switch 3	P-B2	P-B2	P-B2	P-B2	P-B2				
Pump Switch 4	P-B3	P-B3	P-B3	P-B3	P-B3				
Pump Switch 5	P-B4	P-B4	P-B4	P-B4	P-B4				
Pump Switch 6	P-B5	P-B5	P-B5	P-B5	P-B5				
Pump Switch 7	P-B6	P-B6	P-B6	P-B6	P-B6				
Pump Inhibit	P-B7	P-B7	P-B7	P-B7	P-B7				
Line Contactor	M-B8	M-B8	M-B8	M-B8	M-B8				
Power Steer Contactor	M-B9	M-B9	M-B9	M-B9	M-B9				
External LED	S-B9	S-B9	S-B9	S-B9	S-B9				

Table 7. Digital Functions for Dual Traction and Pump

Analogue Inputs Personality:

Analogue Function	Value of Analogue Input Configuration Item															
	1	2	3	4	5	6	7	8	9	10	11	12	13	14	15	16
Accelerator	M-B10	M-B11	M-B10	M-B11	M-B10	M-B11	M-B10	M-B11	M-B10	M-B11	M-B10	M-B11	M-B10	M-B11	M-B10	M-B11
Footbrake	M-B11	M-B10			M-B11	M-B10	M-B11	M-B10			M-B11	M-B10				
Economy	S-B10	S-B10	M-B11	M-B10	S-B10	S-B10	S-B10	S-B10	M-B11	M-B10	S-B10	S-B10	M-B11	M-B10	M-B11	M-B10
Steer Pot	S-B11	S-B11	S-B11	S-B11			S-B11	S-B11	S-B11	S-B11						
Pump Lift Accelerator A	P-B10	P-B10	P-B10	P-B10	P-B10	P-B10	P-B11	P-B11	P-B11	P-B11	P-B11	P-B11	P-B10	P-B10	P-B11	P-B11
Pump Lift Accelerator B	P-B11	P-B11	P-B11	P-B11	P-B11	P-B11	P-B10	P-B10	P-B10	P-B10	P-B10	P-B10	P-B11	P-B11	P-B10	P-B10

Table 8. Analogue Functions for Dual Traction and Pump